

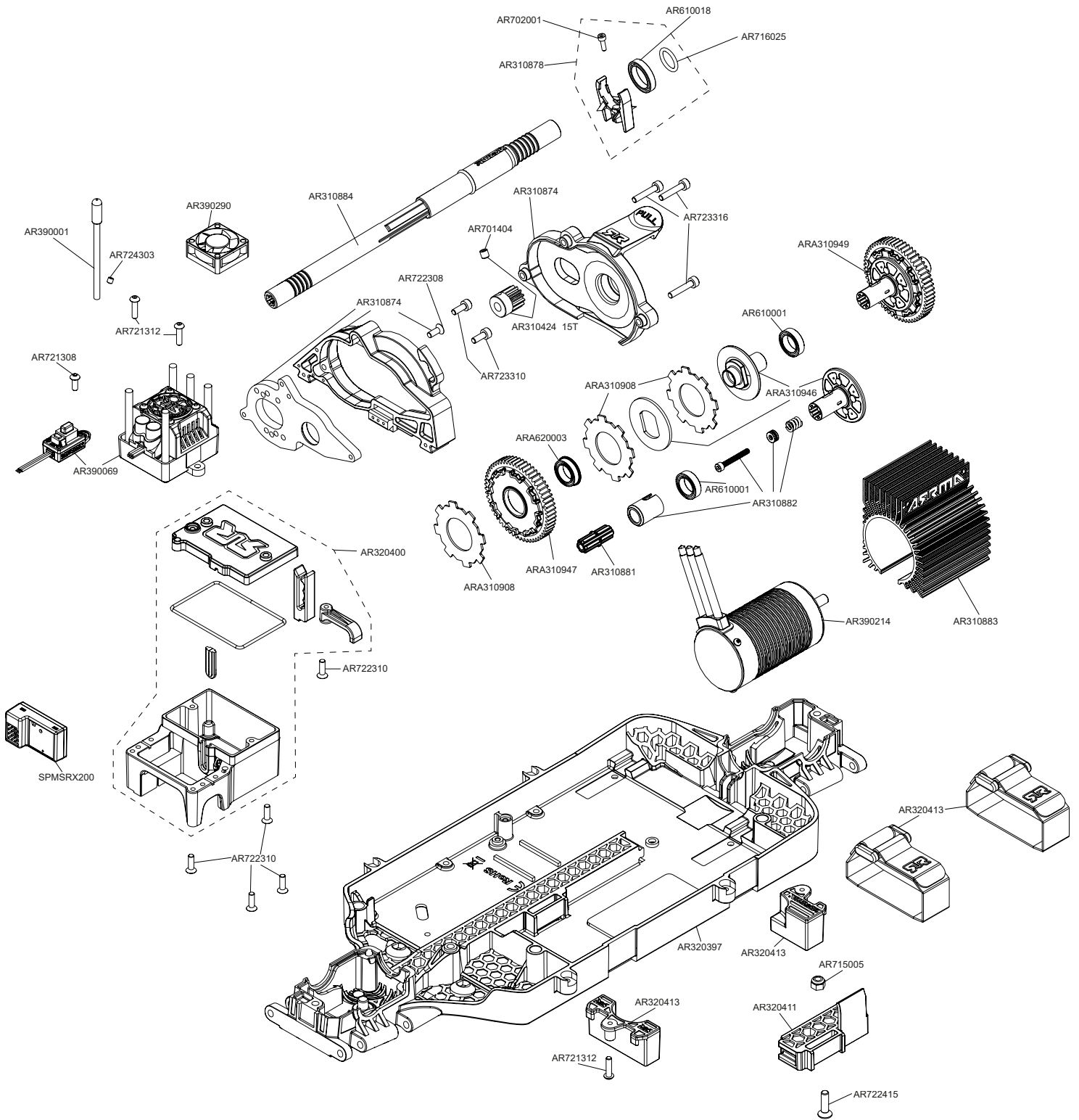

Front Vorne Avant Delantero フロント 前



Centre Center  
 Centre Centro  
 センター 中心





Rear Hinten Arrière Trasero リア后

Shocks Stoßdämpfer Amortisseur  
Amortiguador 減震器 ショックアブソーバ

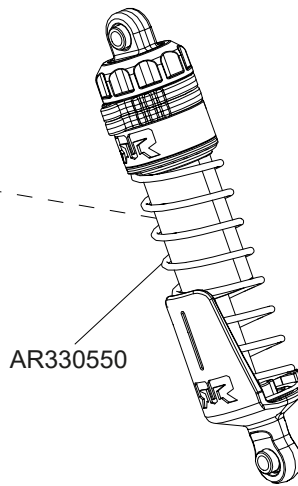
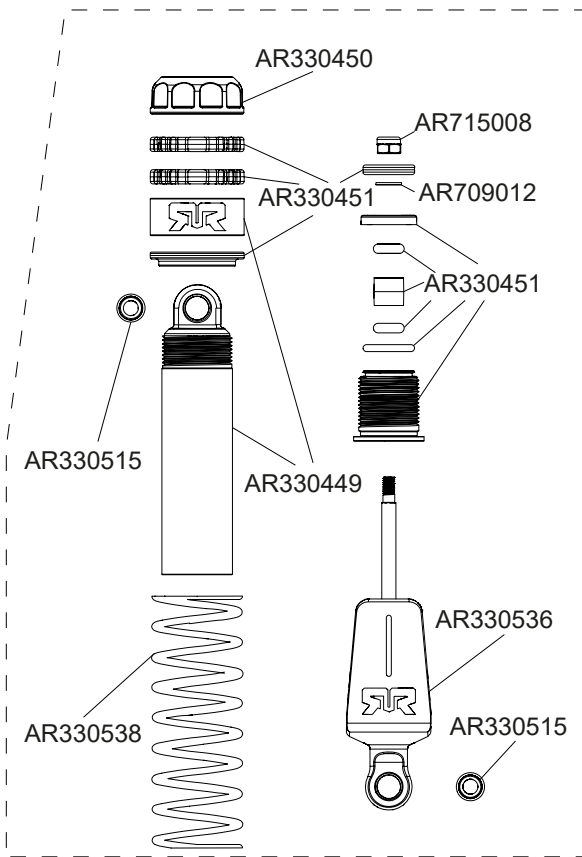

Front Vorne Avant  
Delantero フロント 前

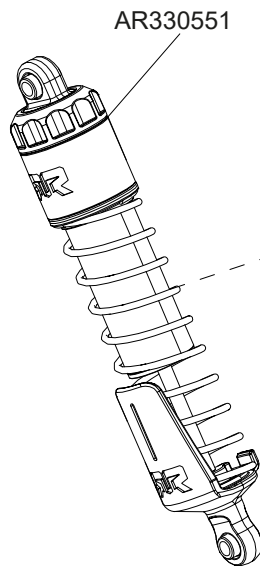
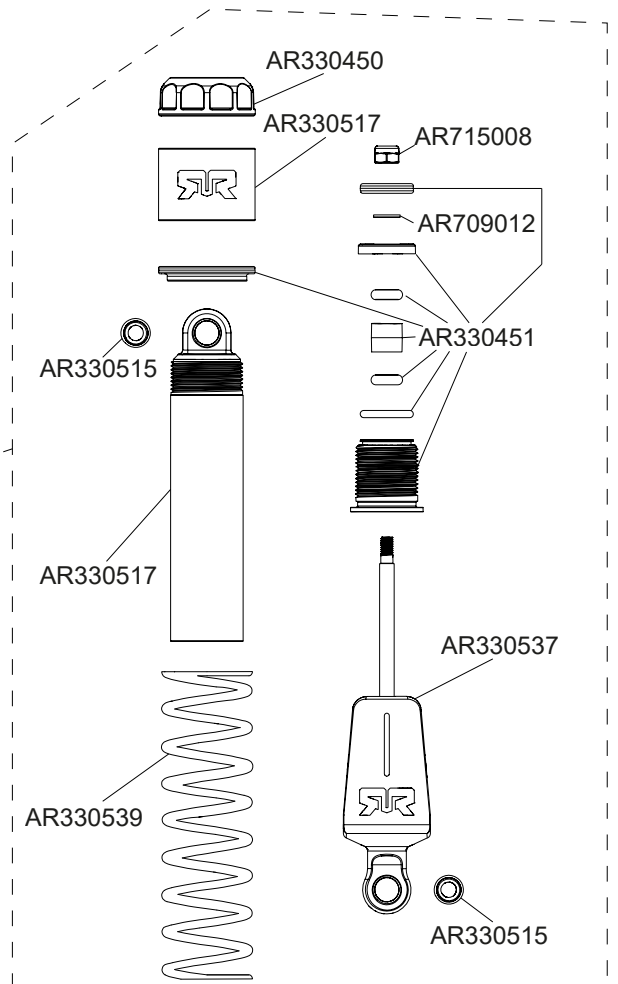

Rear Hinten Arrière  
Trasero リア后

Differential Differential Différentiel  
Diferencial 差动 差動

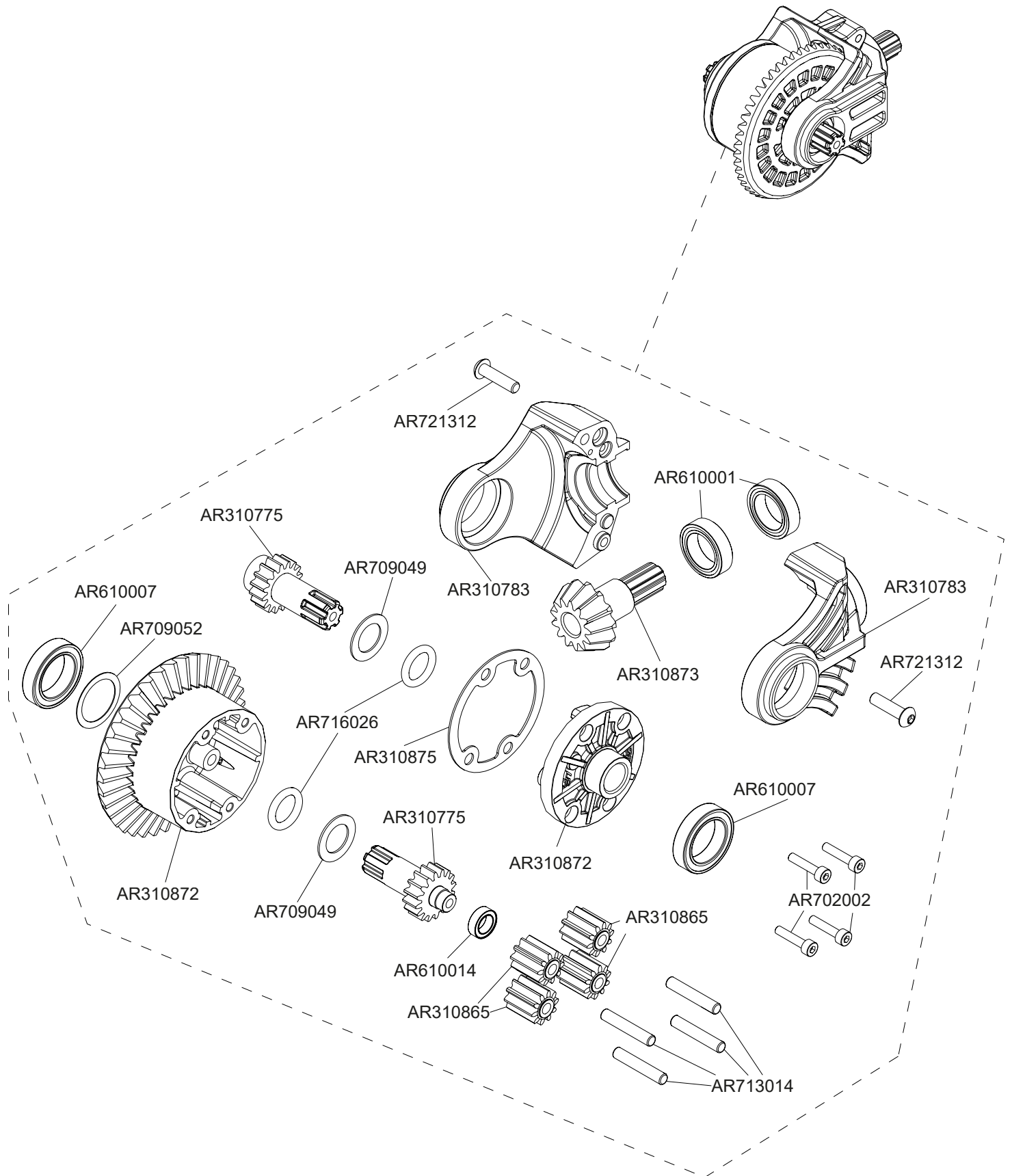

Body & Tire Karosserie & Reifen  
Carrosserie & Pneu  
Cuerpo & Neumático  
车身及轮胎 ボディとタイヤ

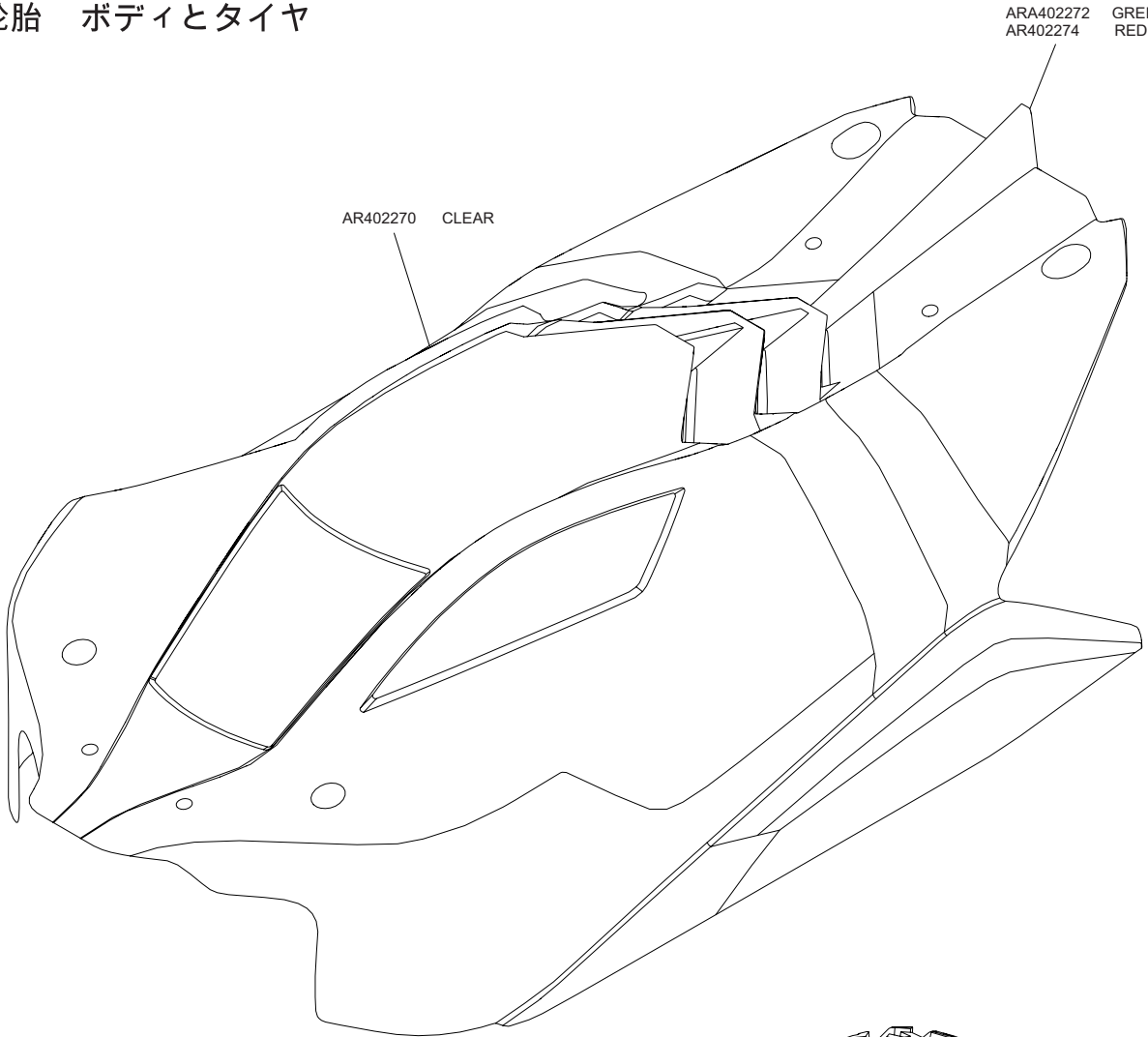

AR402270 CLEAR

ARA402272 GREEN  
AR402274 RED

PRE GLUED  
AR550057 BLACK

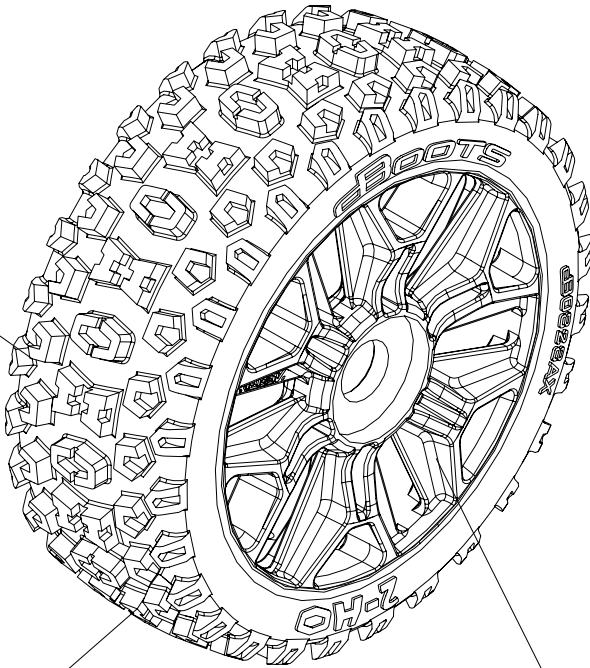

TIRE  
AR520053

WHEELS  
AR510120 BLACK