

 **BLADE**®

INDUCTRIX® **SWITCH AIR**

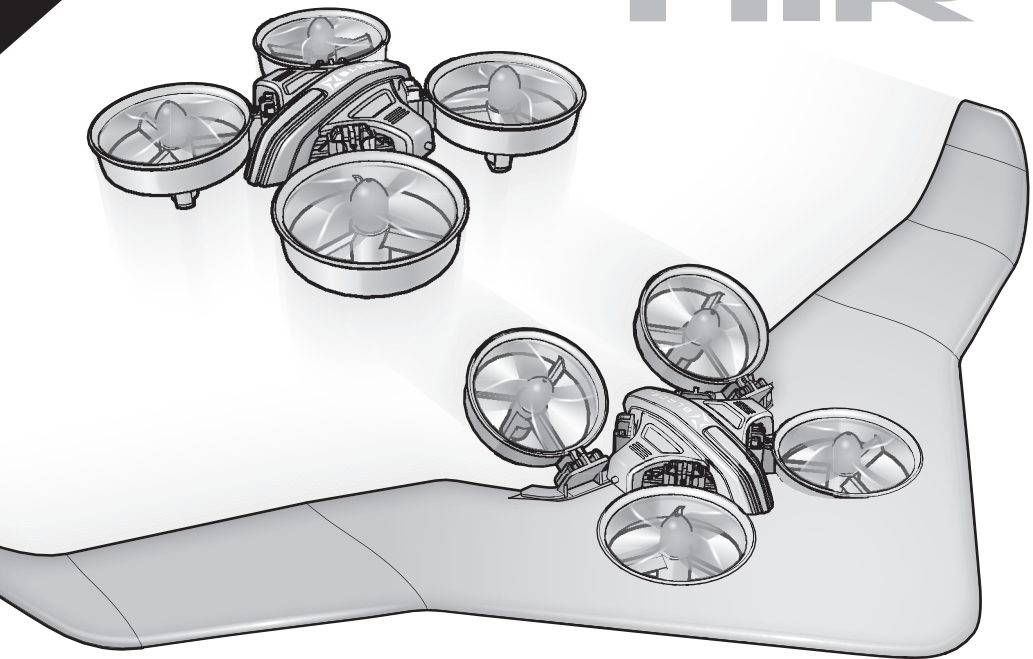

Instruction Manual
Bedienungsanleitung
Manuel d'utilisation
Manuale di Istruzioni



SAFE® **RTF** **BNF**®

HORIZON®
H O B B Y

NOTICE

All instructions, warranties and other collateral documents are subject to change at the sole discretion of Horizon Hobby, LLC. For up-to-date product literature, visit horizonhobby.com and click on the support tab for this product.

Meaning of Special Language

The following terms are used throughout the product literature to indicate various levels of potential harm when operating this product:

WARNING: Procedures, which if not properly followed, create the probability of property damage, collateral damage, and serious injury OR create a high probability of superficial injury.

CAUTION: Procedures, which if not properly followed, create the probability of physical property damage AND a possibility of serious injury.

NOTICE: Procedures, which if not properly followed, create a possibility of physical property damage AND a little or no possibility of injury.

 **WARNING:** Read the ENTIRE instruction manual to become familiar with the features of the product before operating. Failure to operate the product correctly can result in damage to the product, personal property and cause serious injury.

This is a sophisticated hobby product. It must be operated with caution and common sense and requires some basic mechanical ability. Failure to operate this Product in a safe and responsible manner could result in injury or damage to the product or other property. This product is not intended for use by children without direct adult supervision. Do not use with incompatible components or alter this product in any way outside of the instructions provided by Horizon Hobby, LLC. This manual contains instructions for safety, operation and maintenance. It is essential to read and follow all the instructions and warnings in the manual, prior to assembly, setup or use, in order to operate correctly and avoid damage or serious injury.

Age Recommendation: Not for children under 14 years. This is not a toy.

Safety Precautions and Warnings

- Always keep a safe distance in all directions around your model to avoid collisions or injury. This model is controlled by a radio signal subject to interference from many sources outside your control. Interference can cause momentary loss of control.
- Always operate your model in open spaces away from full-size vehicles, traffic and people.
- Always carefully follow the directions and warnings for this and any optional support equipment (chargers, rechargeable battery packs, etc.).
- Always keep all chemicals, small parts and anything electrical out of the reach of children.
- Always avoid water exposure to all equipment not specifically designed and protected for this purpose. Moisture causes damage to electronics.
- Never place any portion of the model in your mouth as it could cause serious injury or even death.
- Never operate your model with low transmitter batteries.
- Always keep aircraft in sight and under control.
- Always move the throttle fully down at rotor strike.
- Always use fully charged batteries.
- Always keep transmitter powered on while aircraft is powered.
- Always remove batteries before disassembly
- Always keep moving parts clean.
- Always keep parts dry.
- Always let parts cool after use before touching.
- Always remove batteries after use.
- Never operate aircraft with damaged wiring.
- Never touch moving parts.

USB Charging Warnings

The Battery Charger (EFLC1008) included with your hovercraft has been designed to safely charge the Li-Po battery.

 **WARNING:** Failure to exercise caution while using this product and comply with the following warnings could result in product malfunction, electrical issues, excessive heat, FIRE, and ultimately injury and property damage.

- NEVER LEAVE CHARGING BATTERIES UNATTENDED.
- NEVER CHARGE BATTERIES OVERNIGHT.
- Never attempt to charge dead, damaged or wet battery packs.
- Never attempt to charge a battery pack containing different types of batteries.
- Never allow children under 14 years of age to charge battery packs.
- Never charge batteries in extremely hot or cold places or place in direct sunlight.
- Never charge a battery if the cable has been pinched or shorted.
- Never connect the charger if the power cable has been pinched or shorted.

- Never attempt to dismantle the charger or use a damaged charger.
- Always use only rechargeable batteries designed for use with this type of charger.
- Always inspect the battery before charging.
- Always keep the battery away from any material that could be affected by heat.
- Always monitor the charging area and have a fire extinguisher available at all times.
- Always end the charging process if the battery becomes hot to the touch or starts to change form (swell) during the charge process.
- Always connect the positive leads (+) and negative leads (-) correctly.
- Always disconnect the battery after charging, and let the charger cool between charges.
- Always charge in a well-ventilated area.
- Always terminate all processes and contact Horizon Hobby if the product malfunctions.

- Charge only rechargeable batteries. Charging non-rechargeable batteries may cause the batteries to burst, resulting in injury to persons and/or damage to property.
- The USB outlet shall be installed near the equipment and shall be easily accessible.

CAUTION: Always ensure the battery you are charging meets the specifications of this charger. Not doing so can result in excessive heat and other related product malfunctions, which can lead to user injury or property damage. Please contact Horizon Hobby or an authorized retailer with compatibility questions.

CAUTION: If at any time during the charge process the battery pack becomes hot or begins to puff, disconnect the battery immediately and discontinue the charge process as batteries can cause fire, collateral damage and injuries.

Table of Contents

Components	3	Air Mode Operation (Beginner Mode).....	9
Specifications	3	Air Mode Operation (Expert Mode).....	12
Box Contents	4	Hovercraft Operation	13
First Flight Preparation	4	Post-Flight Inspection and Maintenance Checklist.....	14
Flying Checklist	4	Troubleshooting Guide	14
Battery Charging.....	4	Exploded View	15
Installing the Transmitter Batteries	5	Replacement Parts.....	15
Installing the Flight Battery	5	Optional Parts	15
SAFE Technology	5	Limited Warranty	16
Transmitter and Receiver Binding.....	6	Warranty and Service Contact Information	17
LED Codes	7	FCC Information.....	17
Transmitter Control	7	IC Information	17
Understanding the Primary Flight Controls	8	Compliance Information for the European Union.....	17
Flying the Switch™ Quadcopter	9		
Switching from Quadcopter Operation to Air Wing Operation.....	9		

Components

	RTF: BLH8300	BNF: BLH8380
Airframe – Blade® Inductrix® Switch Air (BLH8300)	Included	Included
Motors – 6mm Brushed, (BLH8521)	Installed	Installed
On-board Electronics – Main control board, SAFE® (BLH9802)	Installed	Installed
Battery – 150mAh 1S 3.7V 25C Li-Po (EFLB1501S25)	Included	Included
Charger – 1S USB Li-Po Charger, 3.7V (EFLC1008)	Included	Included
Transmitter – MLP4DSM 2.4GHz, 4 CH Transmitter, BCMX2 (EFLH1064B)	Included	Required

Specifications

Wingspan	13.98 in (35.5cm)	Flying Weight	.95 oz (27 g)
Propeller Diameter	1.81 in (30mm)		

To register your product online, visit www.bladeheli.com

Box Contents

- Blade® Inductrix® Switch Air
- 3.7V 25C 150mAh 1S Li-Po Battery
- 1S USB Li-Po Charger
- MLP4DSM Transmitter (RTF only)
- 4 AA Batteries (RTF only)

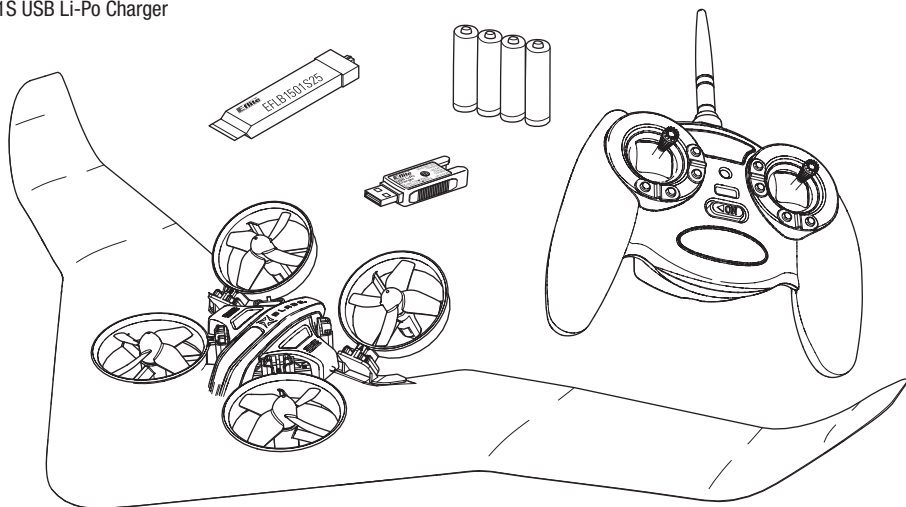

First Flight Preparation

- Remove and inspect contents
- Begin charging the flight battery
- Install the flight battery in the quadcopter (once it has been fully charged)
- Familiarize yourself with the controls
- Find a suitable area for flying

Flying Checklist

- Always turn the transmitter on first
- Plug the flight battery into the lead from the control unit
- Allow the control unit to initialize and arm properly
- Fly the model
- Land the model
- Unplug the flight battery from the 5-in-1 control unit
- Always turn the transmitter off last

Battery Charging

NOTICE: Charge only batteries that are cool to the touch and are not damaged. Look at the battery to make sure it is not damaged e.g., swollen, bent, broken or punctured.

1. Insert the charger into a USB port.
2. Properly connect the battery to the charger.
3. Always disconnect the flight battery from the charger immediately upon completion of charging.

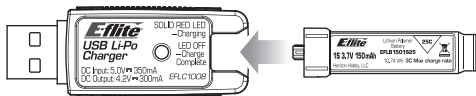

CAUTION: Only use chargers specifically designed to charge the included Li-Po battery. Failure to do so could result in fire, causing injury or property damage.

CAUTION: Never exceed the recommended charge rate.

LED Indications

When you make the connection successfully, the LED on the charger turns solid red, indicating charging has begun. Charging a fully discharged (not over-discharged) 150mAh battery takes approximately 30 minutes. The light goes out when the charge is complete.

CHARGING (Solid Red)

MAX CHARGE (OFF)

CAUTION: Once charging is complete, immediately remove the battery. Never leave a battery connected to the charger.

Installing the Transmitter Batteries

Replace the transmitter batteries when the power LED flashes and the transmitter beeps.

CAUTION: NEVER remove the transmitter batteries while the model is powered on. Loss of model control, damage, or injury may occur.

CAUTION: Risk of explosion if battery is replaced by an incorrect type. Dispose of used batteries according to national regulations.

CAUTION: If using rechargeable batteries, charge only rechargeable batteries. Charging non-rechargeable batteries may cause the batteries to burst, resulting in injury to persons and/or damage to property.

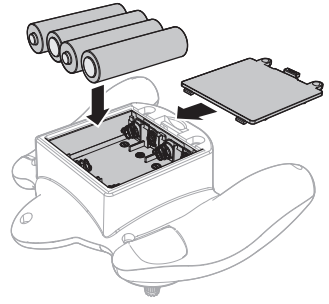

Installing the Flight Battery

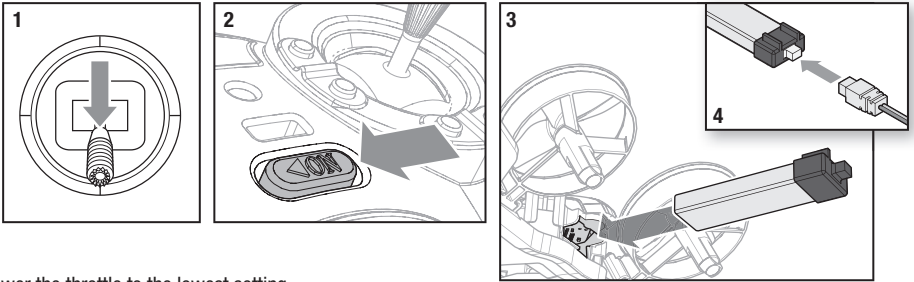

1. Lower the throttle to the lowest setting.
2. Power on the transmitter.
3. Install the battery by sliding it into the battery mounting slot below the control unit. Slide the battery into the slots with the label facing upward so that the battery key molded into the battery end-cap comes in contact with the key on the battery slot.
4. Connect the battery cable to the control unit.
5. Place the craft on a flat surface and leave the craft still until the LED on the control unit indicates one of the following flight modes:
 - Solid white: Air mode
 - Solid blue: Multirotor mode
 - Solid green: Hovercraft mode (1 stick)
 - Solid amber: Hovercraft mode (2 stick)

CAUTION: Always disconnect the Li-Po battery from the aircraft when not flying to avoid over-discharging the battery. Batteries discharged to a voltage lower than the lowest approved voltage may become damaged, resulting in loss of performance and potential fire when batteries are charged.

SAFE® Technology

Revolutionary SAFE® (Sensor Assisted Flight Envelope) technology uses an innovative combination of multi-axis sensors and software that allows model aircraft to know its position relative to the horizon. This spatial awareness is utilized to create a controlled flight envelope the aircraft can use to maintain a safe region of bank and pitch angles so you can fly more safely. Far beyond stability, this level of protection offers multiple modes so the pilot can choose to develop his or her skills with a greater degree of security and flight control that always feels crisp and responsive.

SAFE technology delivers:

- Flight envelope protection you can enable at the flip of a switch.
- Multiple modes let you adapt SAFE technology to your skill level instantly.

Best of all, sophisticated SAFE technology doesn't require any work to enjoy. Every aircraft with SAFE installed is ready to use and optimized to offer the best possible flight experience.

FlySAFERC.com

RTF

Your RTF transmitter comes prebound to the model. If you need to re-bind, follow the directions below.

MLP4DSM Binding Procedure

1. Disconnect the flight battery from the quadcopter.
2. Center all trims on your transmitter.
3. Power off the transmitter and move the throttle stick to the down/off position.
4. Connect the flight battery in the quadcopter. The LED on the control unit flashes after 5 seconds.
5. When the blue light is flashing, push in and hold down the left stick* while powering on the transmitter (you will hear a 'click').
6. Release the left stick. The transmitter will beep and the power LED will blink.
7. The quadcopter is bound when all of the LEDs on the aircraft turn solid.
8. Disconnect the flight battery and power the transmitter off.

* The trigger switch may also be used for the binding procedure.

If you encounter problems, obey binding instructions and refer to the troubleshooting guide for other instructions. If needed, contact the appropriate Horizon Product Support office. For a list of compatible DSM® transmitters, please visit www.bindnfly.com.



If you are using a computer transmitter, set the model type to "Acro" or "Airplane" mode. In the channel input menu, set channel 6 (Aux1) to a momentary switch such as the bind button (I) and channel 5 (Gear) to a 3-position switch (switch B). In the Servo Setup menu, reverse channel 6 (Aux1).

Bind the quadcopter to your transmitter following the Transmitter and Receiver Binding directions below.

General Binding Procedure

1. Disconnect the flight battery from the quadcopter.
2. Center all trims on your transmitter.
3. Power off the transmitter and fully lower the throttle.
4. Connect the flight battery in the quadcopter. All of the LEDs on the aircraft will flash rapidly, indicating the aircraft has entered bind mode.
5. Put the transmitter into bind mode while powering on the transmitter.
6. Release the bind button/switch after 2–3 seconds. The quadcopter is bound when all of the LEDs on the aircraft turn solid.
7. Disconnect the flight battery and power the transmitter off.



CAUTION: When using a Futaba® transmitter with a Spektrum™ DSM2®/DSMX® module, you must reverse the throttle channel and re-bind. Refer to your Spektrum module manual for binding and failsafe instructions. Refer to your Futaba transmitter manual for instructions on reversing the throttle channel.

LED Codes

Equipment	LED Color	LED Status	Operation
Flight control LED on the control board, RGB	Red	Solid	Position 2; Quadcopter AS3X mode
	Purple	Solid	Position 1; Quadcopter Horizon mode
	Blue	Solid	Position 0; Quadcopter Stability mode
	Green	Solid	IDX Switch mode 1
	Amber	Solid	IDX Switch mode 2
	White	Solid	Air mode
	Green	Blinks for 1 second at power ON	Battery voltage check; Full
	Orange	Blinks for 1 second at power ON	Battery voltage check; Middle
	Red	Blinks for 1 second at power ON	Battery voltage check; Low
	Blue	Blinking rapidly	Bind mode
	Blue	Blinking slowly	2.4GHz signal lost, Low voltage warning
Front LEDs	White	Blinking rapidly	Bind mode
		Solid	Arm
		Blinking slowly	Disarm
		Blinking slowly	2.4GHz signal lost, Low voltage warning
		Blinking slowly	2.4GHz signal lost, Low voltage warning
Rear LEDs	Red	Blinking rapidly	Bind mode
		Solid	Arm / Disarm
		Blinking slowly	2.4GHz signal lost, Low voltage warning

Transmitter Control

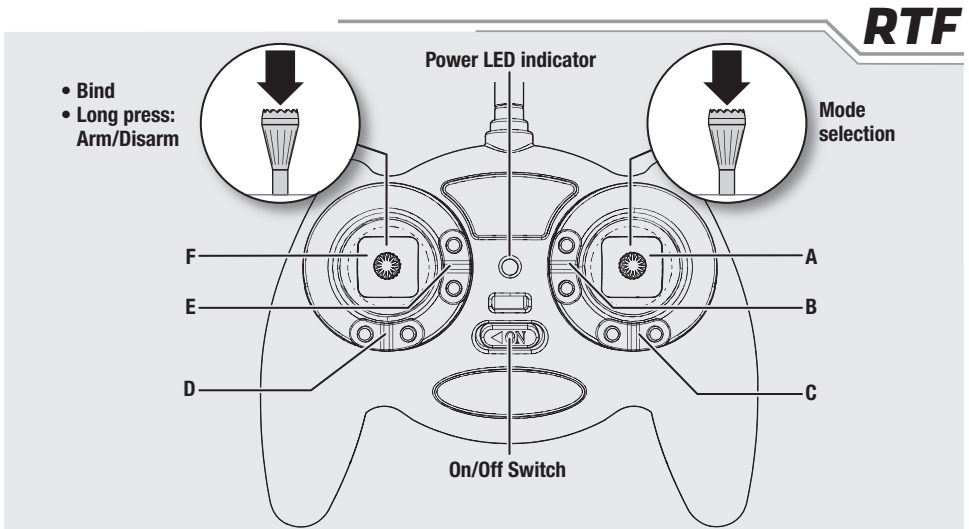

When pressed down, trim buttons make a sound that increases or decreases in pitch at each pressing. The middle or neutral trim position is heard as a middle tone in the pitch range of the sounds. The end of the control range is sounded by a series of beeps.

	A	B	C	D	E	F
Mode 1	Aileron (Left/Right) Throttle (Up/Down)	Throttle Trim	Aileron Trim	Rudder Trim	Elevator Trim	Rudder (Left/Right) Elevator (Up/Down)
Mode 2	Aileron (Left/Right) Elevator (Up/Down)	Elevator Trim	Aileron Trim	Rudder Trim	Throttle Trim	Rudder (Left/Right) Throttle (Up/Down)

Understanding the Primary Flight Controls

If you are not familiar with the controls of your Inductrix® Switch Air wing and quadcopter, take a few minutes to familiarize yourself with them before attempting your first flight.

Quadcopter Operation

To select Quadcopter mode, with the aircraft and transmitter powered on and bound, press both sticks to the outside bottom corners for 3 seconds.

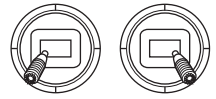

Quadcopter Flight Modes

Change flight modes by pushing down on the right stick. Ensure the flight mode switch is in the desired position before flying.

- In Stability mode (switch position 0), the controls provide a minimum bank angle. This mode is shown by the flight control LEDs on the quadcopter glowing solid blue.
- Agility mode (switch position 2) is shown by the flight control LEDs on the quadcopter glowing solid red.

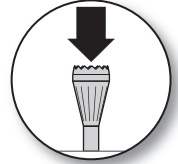

Throttle

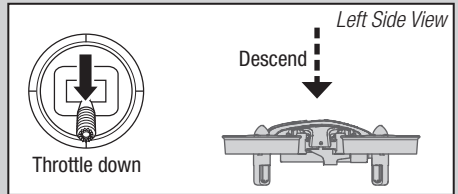
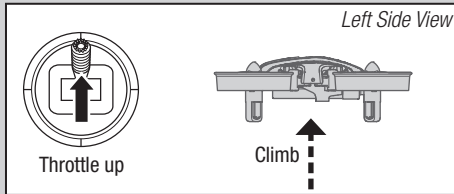

Elevator

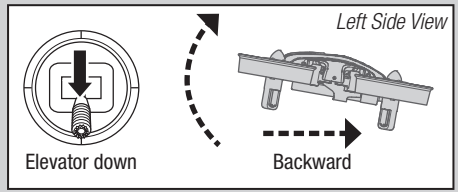
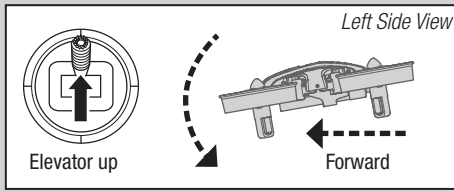

Aileron

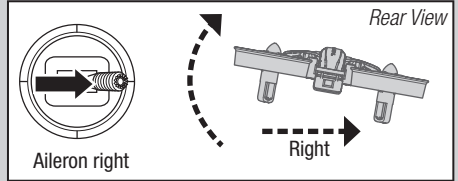
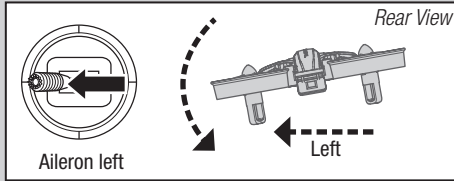

Rudder

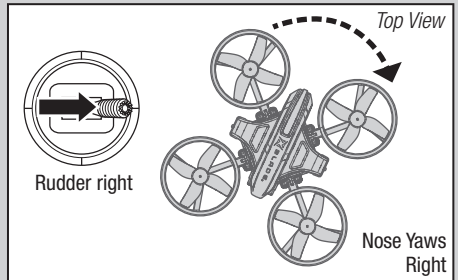
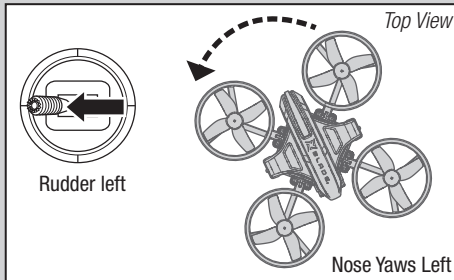

Flying the Switch™ Quadcopter

Takeoff

Increase the throttle until the model is approximately 2 ft. (600mm) off the ground and check the trim so the model flies as desired. Once the trim is adjusted, begin flying the model.

Typical flight times for the included battery range from 3 to 4 minutes.

Low Voltage Cutoff (LVC)

LVC decreases the power to the motors when the battery voltage gets low. When the motor power decreases and the front and rear FC LEDs flash red, land the aircraft immediately and recharge the flight battery.

LVC does not prevent the battery from over-discharge during storage.

NOTICE: Repeated flying to LVC will damage the battery.

Landing

To land, slowly decrease the throttle while in a low-level hover. After landing, hold the arm/disarm switch until the motors have stopped, then remove the battery. Fully charge your battery before storing it. During storage, make sure the battery charge does not fall below 3V per cell.

Switching from Quadcopter Operation to Air Wing Operation

To switch from quadcopter operation to air wing operation, slide the two rear fans down out of the clips on the main frame and slide them into the clips at the rear of the wing base plate. Seat the main frame into the slot in the wing with the two front fans attached ensuring the fans click into their respective openings in the wing.

Air Mode

To select Air Mode, press both sticks to the outside upper corners for 3 seconds. The flight mode LED will glow solid white to indicate Air mode.

Select flight modes by pushing down on the right stick. Ensure the flight mode switch is in the desired position before flying.

- Beginner mode (switch position 0); The Aileron and Rudder controls are combined on the right stick to simplify flight controls for new users.
- Expert Mode (Switch position 2); Standard fixed-wing flight controls for more experienced pilots.

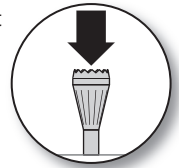
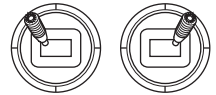

Air Mode Operation (Beginner mode)

Throttle



Throttle up

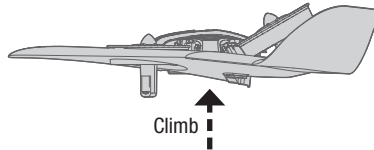

Left Side View

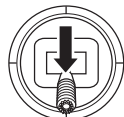

Throttle down

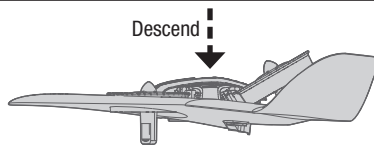

Left Side View

Elevator

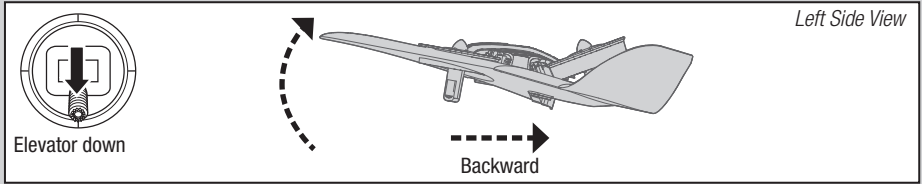
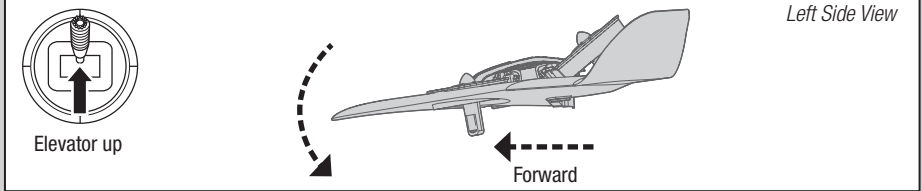

Aileron and Rudder - Right Stick

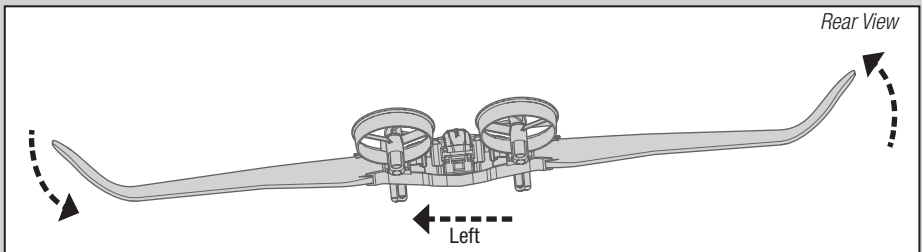
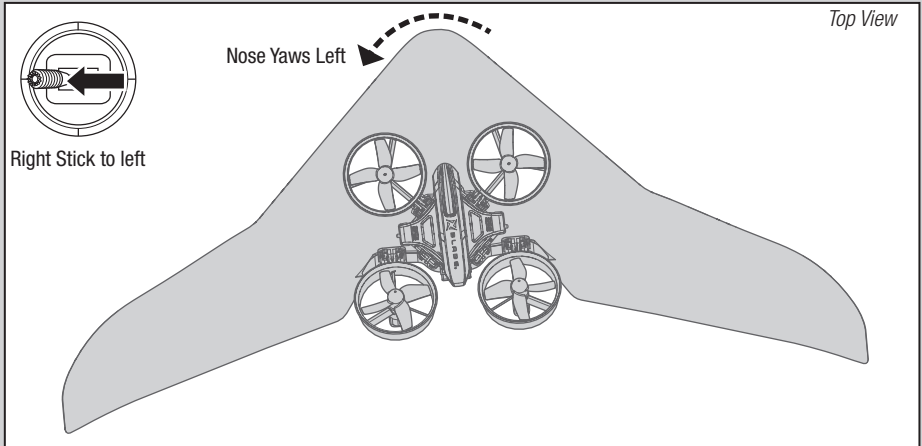

Aileron and Rudder - Right Stick (continued)

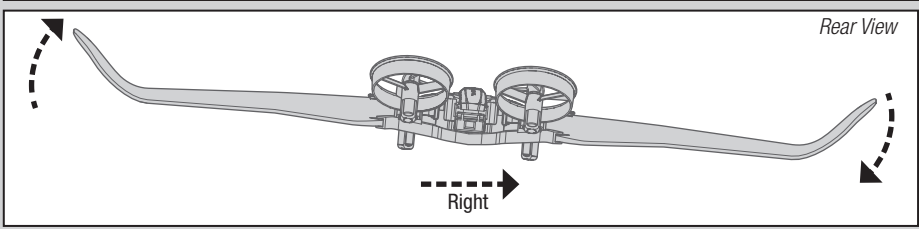
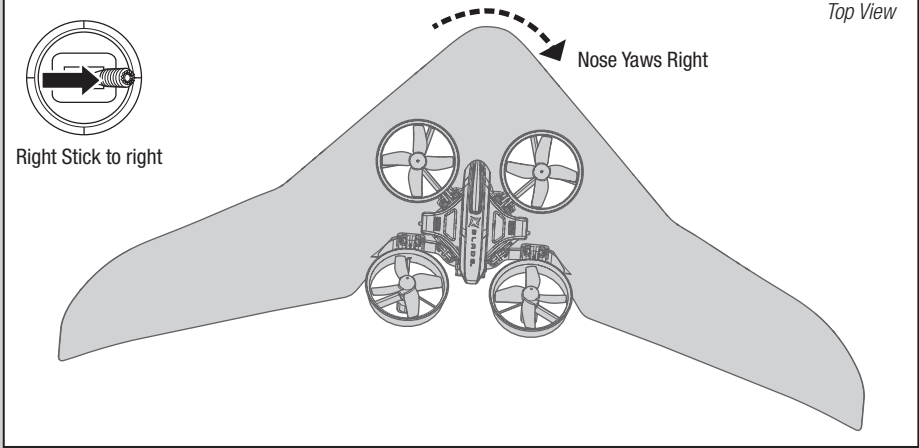

Air Mode Operation (Expert mode)

Throttle

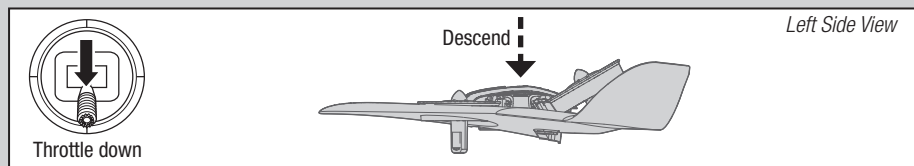
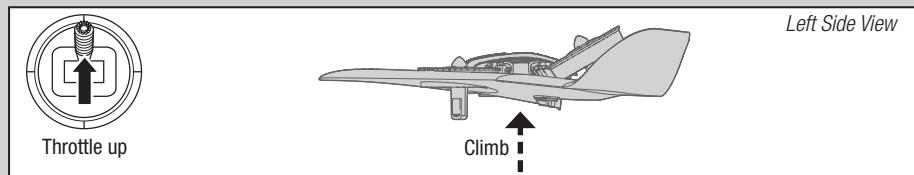

Elevator

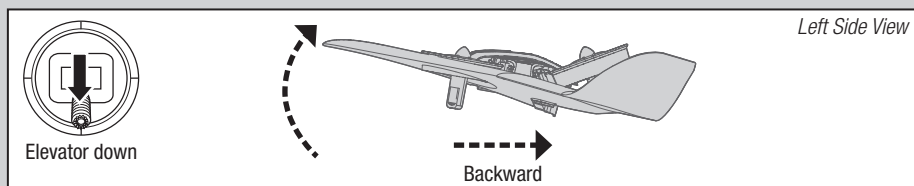
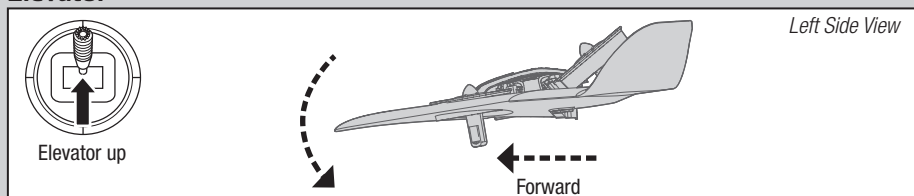

Aileron

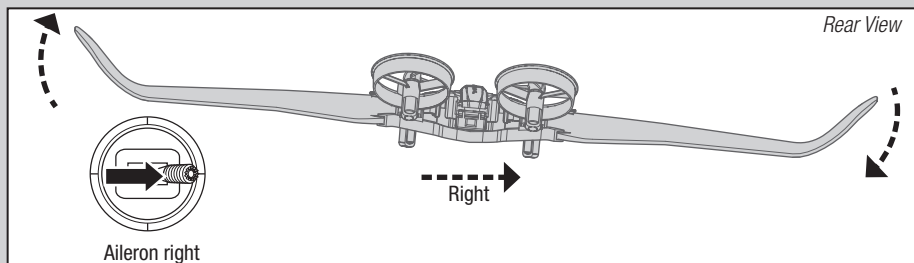
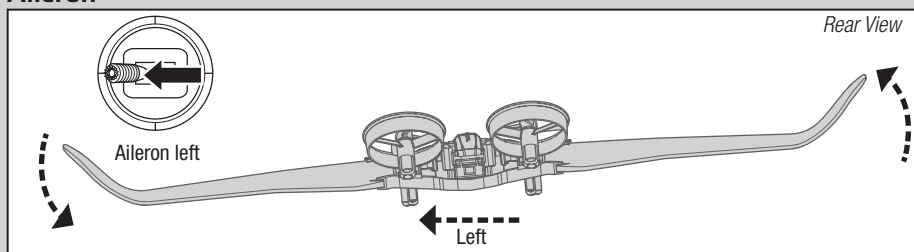

Rudder

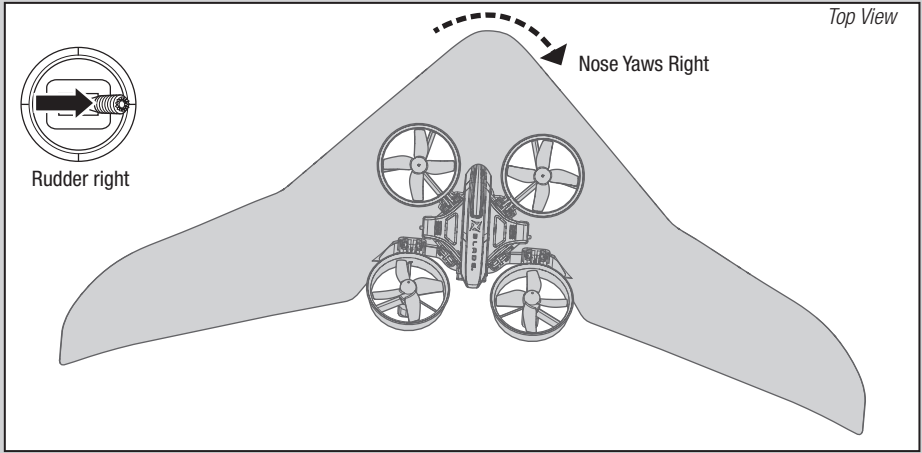
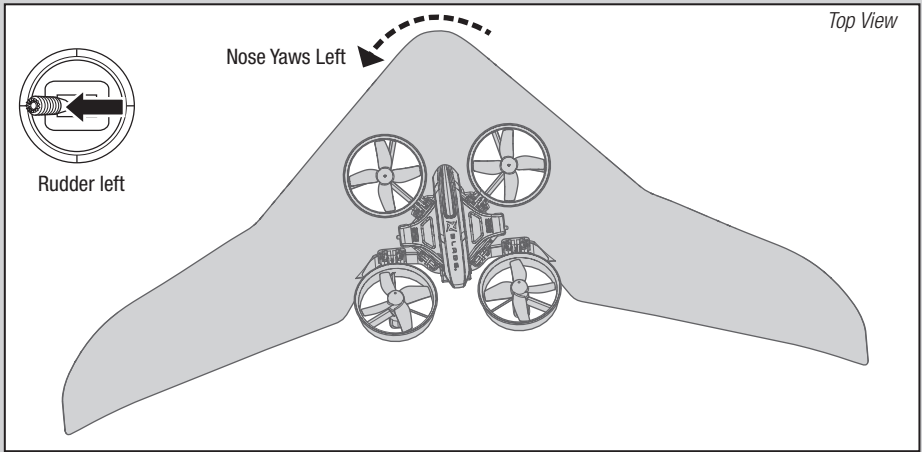

Hovercraft Operation

The hovercraft base plate (BLH9805) and foam skirt (BLH9806) are not included with this product and are sold separately. Please refer to the manual for the Inductrix Switch (BLH9800) for operation in the two hovercraft modes; single-stick or two-stick mode.

Sold Separately

BLH9805
Base plate

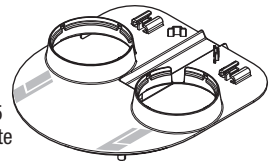

BLH9806
Foam skirt

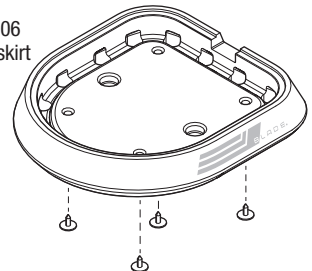

Post-Flight Inspection and Maintenance Checklist

✓		
	Cleaning	Make sure the battery is not connected before cleaning. Remove dust and debris with a soft brush or a dry, lint-free cloth.
	Motors	Replace the motor when the model will not fly steady or veers off when doing a climb out.
	Wiring	Make sure the wiring does not block moving parts. Replace damaged wiring and loose connectors.
	Fasteners	Make sure there are no loose screws, other fasteners or connectors. Do not over-tighten metal screws in plastic parts. Tighten screws so the parts are mated together, then turn the screw only 1/8th of a turn more.
	Propellers	Make sure there is no damage to the propellers or other parts that move at high speed. Damage to these parts includes cracks, burrs, chips or scratches. Replace damaged parts before flying.

Troubleshooting Guide

Problem	Possible Cause	Solution
Quadcopter control response is inconsistent or requires extra trim to neutralize movement.	Aircraft not initialized on a level surface.	Disconnect the flight battery, center the control trim and re-initialize the quadcopter.
	Battery not correctly placed in battery slot.	Adjust battery position so quadcopter balances in the center of the frame.
Quadcopter will not respond to throttle.	Throttle too high and/or throttle trim is too high.	Reset controls with the throttle stick and throttle trim at the lowest setting.
	Quadcopter moved during initialization.	Disconnect the flight battery and re-initialize the quadcopter while keeping the quadcopter from moving.
	Throttle channel is reversed.	Disconnect flight battery, reverse the throttle channel on the transmitter, reconnect flight battery.
Quadcopter does not function and smells burnt after connecting the flight battery.	Flight battery connected with the wrong polarity.	Replace the 5-in-1 board. Connect the flight battery noting proper polarity.
Quadcopter has reduced flight time or is underpowered.	Flight battery charge is low.	Completely recharge the flight battery.
	Inadequate power to flight battery charger.	Use a different USB power source for the charger.
	Flight battery is damaged.	Replace the flight battery and follow the flight battery instructions.
	Flight conditions might be too cold.	Make sure the battery is warm (room temperature) before use.
LED on receiver flashes rapidly and aircraft will not respond to transmitter (during binding).	Transmitter too near aircraft during binding process.	Power off the transmitter. Move the transmitter a larger distance from the aircraft. Disconnect and reconnect the flight battery to the aircraft. Follow the binding instructions.
	Bind switch or button was not held while transmitter was powered on.	Power off transmitter and repeat bind process.
	Aircraft or transmitter is too close to large metal object, wireless source or another transmitter.	Move aircraft and transmitter to another location and attempt binding again.
LED on the receiver flashes rapidly and the quadcopter will not respond to the transmitter (after binding).	Less than a 5-second wait between first powering on the transmitter and connecting the flight battery to the quadcopter.	Leave the transmitter powered on. Disconnect and reconnect the flight battery to the quadcopter.
	The quadcopter is bound to a different model memory (ModelMatch™ transmitters only).	Select the correct model memory on the transmitter. Disconnect and reconnect the flight battery to the quadcopter.
	Flight battery or transmitter battery charge is too low.	Replace or recharge batteries.
	Aircraft or transmitter is too close to large metal object, wireless source or another transmitter.	Move aircraft and transmitter to another location and attempt connecting again.
Crashes immediately upon lift-off	Propellers in wrong locations or incorrect flight mode selected.	Ensure propeller direction and motor direction are correct.

Exploded View

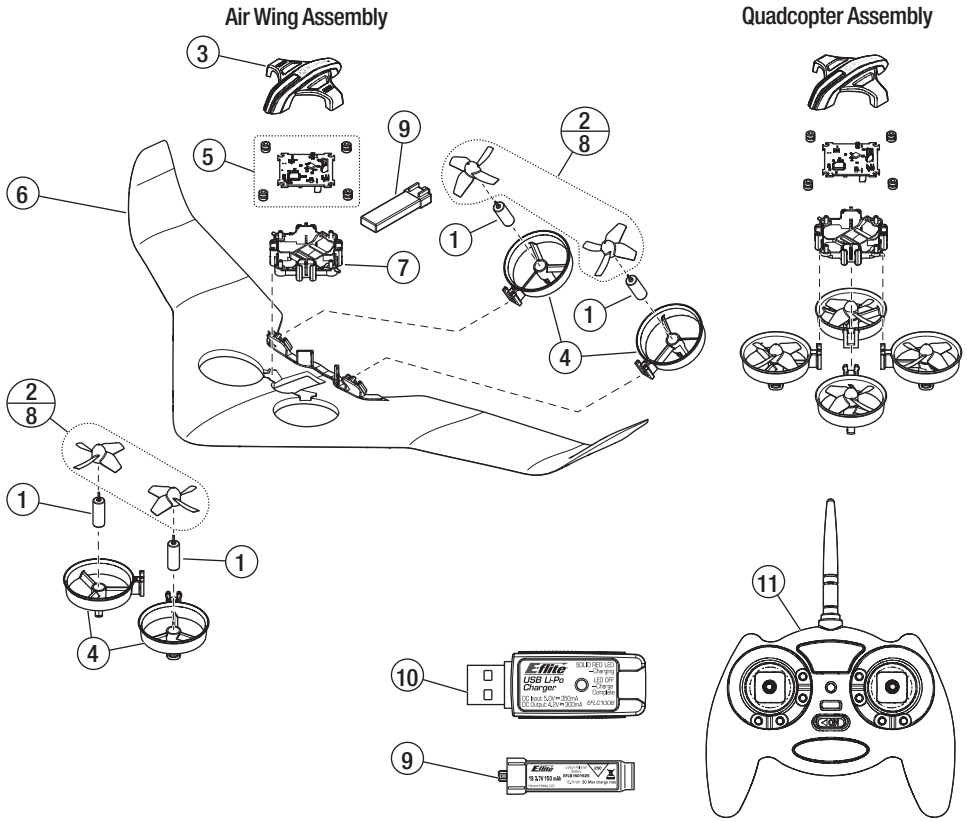

Replacement Parts

Part #	Description
1	BLH8521 Pro Motor Set (4)
2	BLH8705 Propeller Set, White (4)
3	BLH9807 Canopy, Red
4	BLH9803 Duct Set (2)
5	BLH9802 Control Board
6	BLH08301 Replacement Wing

Part #	Description
7	BLH9804 Main Frame
8	BLH9801 Propeller Set (4)
9	EFLB1501S25 3.7V 150mAh 1S 25C LiPo
10	EFLC1008 1S USB LiPo charger, 350mAh
11	EFLH1064/B Blade MLP4DSM 4CH transmitter, 2.4GHz: BMCX2, 120SR

Optional Parts

Part #	Description
BLH8302	LED Nav light set: Inductrix Switch Air
BLH7840	USB: Multi Rotor Programmer
EFLB2001S45	3.7V 200mAh 1S 45C LiPo

Part #	Description
BLH8852	Camera with OSD
BLH9809	Canopy option set (blue) with props

Limited Warranty

What this Warranty Covers

Horizon Hobby, LLC, (Horizon) warrants to the original purchaser that the product purchased (the "Product") will be free from defects in materials and workmanship at the date of purchase.

What is Not Covered

This Warranty is not transferable and does not cover (i) cosmetic damage, (ii) damage due to acts of God, accident, misuse, abuse, negligence, commercial use, or due to improper use, installation, operation or maintenance, (iii) modification of or to any part of the Product, (iv) attempted service by anyone other than a Horizon Hobby authorized service center, (v) Product not purchased from an authorized Horizon dealer, or (vi) Product not compliant with applicable technical regulations.

OTHER THAN THE EXPRESS WARRANTY ABOVE, HORIZON MAKES NO OTHER WARRANTY OR REPRESENTATION, AND HEREBY DISCLAIMS ANY AND ALL IMPLIED WARRANTIES, INCLUDING, WITHOUT LIMITATION, THE IMPLIED WARRANTIES OF NON-INFRINGEMENT, MERCHANTABILITY AND FITNESS FOR A PARTICULAR PURPOSE. THE PURCHASER ACKNOWLEDGES THAT THEY ALONE HAVE DETERMINED THAT THE PRODUCT WILL SUITABLY MEET THE REQUIREMENTS OF THE PURCHASER'S INTENDED USE.

Purchaser's Remedy

Horizon's sole obligation and purchaser's sole and exclusive remedy shall be that Horizon will, at its option, either (i) service, or (ii) replace, any Product determined by Horizon to be defective. Horizon reserves the right to inspect any and all Product(s) involved in a warranty claim. Service or replacement decisions are at the sole discretion of Horizon. Proof of purchase is required for all warranty claims. SERVICE OR REPLACEMENT AS PROVIDED UNDER THIS WARRANTY IS THE PURCHASER'S SOLE AND EXCLUSIVE REMEDY.

Limitation of Liability

HORIZON SHALL NOT BE LIABLE FOR SPECIAL, INDIRECT, INCIDENTAL OR CONSEQUENTIAL DAMAGES, LOSS OF PROFITS OR PRODUCTION OR COMMERCIAL LOSS IN ANY WAY, REGARDLESS OF WHETHER SUCH CLAIM IS BASED IN CONTRACT, WARRANTY, TORT, NEGLIGENCE, STRICT LIABILITY OR ANY OTHER THEORY OF LIABILITY, EVEN IF HORIZON HAS BEEN ADVISED OF THE POSSIBILITY OF SUCH DAMAGES. Further, in no event shall the liability of Horizon exceed the individual price of the Product on which liability is asserted. As Horizon has no control over use, setup, final assembly, modification or misuse, no liability shall be assumed nor accepted for any resulting damage or injury. By the act of use, setup or assembly, the user accepts all resulting liability. If you as the purchaser or user are not prepared to accept the liability associated with the use of the Product, purchaser is advised to return the Product immediately in new and unused condition to the place of purchase.

Law

These terms are governed by Illinois law (without regard to conflict of law principals). This warranty gives you specific legal rights, and you may also have other rights which vary from state to state. Horizon reserves the right to change or modify this warranty at any time without notice.

WARRANTY SERVICES

Questions, Assistance, and Services

Your local hobby store and/or place of purchase cannot provide warranty support or service. Once assembly, setup or use of the Product has been started, you must contact your local distributor or Horizon directly. This will enable Horizon to better answer your questions and service you in the event that you may need any assistance. For questions or assistance, please visit our website

at www.horizonhobby.com, submit a Product Support Inquiry, or call the toll free telephone number referenced in the Warranty and Service Contact Information section to speak with a Product Support representative.

Inspection or Services

If this Product needs to be inspected or serviced and is compliant in the country you live and use the Product in, please use the Horizon Online Service Request submission process found on our website or call Horizon to obtain a Return Merchandise Authorization (RMA) number. Pack the Product securely using a shipping carton. Please note that original boxes may be included, but are not designed to withstand the rigors of shipping without additional protection. Ship via a carrier that provides tracking and insurance for lost or damaged parcels, as Horizon is not responsible for merchandise until it arrives and is accepted at our facility. An Online Service Request is available at http://www.horizonhobby.com/content/_service-center_render-service-center. If you do not have internet access, please contact Horizon Product Support to obtain a RMA number along with instructions for submitting your product for service. When calling Horizon, you will be asked to provide your complete name, street address, email address and phone number where you can be reached during business hours. When sending product into Horizon, please include your RMA number, a list of the included items, and a brief summary of the problem. A copy of your original sales receipt must be included for warranty consideration. Be sure your name, address, and RMA number are clearly written on the outside of the shipping carton.

NOTICE: Do not ship LiPo batteries to Horizon. If you have any issue with a LiPo battery, please contact the appropriate Horizon Product Support office.

Warranty Requirements

For Warranty consideration, you must include your original sales receipt verifying the proof-of-purchase date.

Provided warranty conditions have been met, your Product will be serviced or replaced free of charge. Service or replacement decisions are at the sole discretion of Horizon.

Non-Warranty Service

Should your service not be covered by warranty, service will be completed and payment will be required without notification or estimate of the expense unless the expense exceeds 50% of the retail purchase cost.

By submitting the item for service you are agreeing to payment of the service without notification. Service estimates are available upon request. You must include this request with your item submitted for service. Non-warranty service estimates will be billed a minimum of ½ hour of labor. In addition you will be billed for return freight. Horizon accepts money orders and cashier's checks, as well as Visa, MasterCard, American Express, and Discover cards. By submitting any item to Horizon for service, you are agreeing to Horizon's Terms and Conditions found on our website http://www.horizonhobby.com/content/_service-center_render-service-center.

ATTENTION: Horizon service is limited to Product compliant in the country of use and ownership. If received, a non-compliant Product will not be serviced. Further, the sender will be responsible for arranging return shipment of the un-serviced Product, through a carrier of the sender's choice and at the sender's expense. Horizon will hold non-compliant Product for a period of 60 days from notification, after which it will be discarded.

10/2015

Warranty and Service Contact Information

Country of Purchase	Horizon Hobby	Contact Information	Address
United States of America	Horizon Service Center (Repairs and Repair Requests)	servicecenter.horizonhobby.com/ RequestForm/	2904 Research Rd Champaign, Illinois 61822 USA
	Horizon Product Support (Product Technical Assistance)	productsupport@horizonhobby.com 877-504-0233	
	Sales	websales@horizonhobby.com 800-338-4639	
European Union	Horizon Technischer Service Sales: Horizon Hobby GmbH	service@horizonhobby.eu +49 (0) 4121 2655 100	Hanskampring 9 D 22885 Barsbüttel, Germany

FCC Information

FCC ID (Transmitter): BRDXMTX10

FCC ID (Aircraft): BRWBLH9706



Supplier's Declaration of Conformity Blade Inductrix Switch Air 1 BLH8380

This device complies with part 15 of the FCC rules. Operation is subject to the following two conditions: (1) This device may not cause harmful interference, and (2) this device must accept any interference received, including interference that may cause undesired operation.



CAUTION: Changes or modifications not expressly approved by the party responsible for compliance could void the user's authority to operate the equipment.

This product contains a radio transmitter with wireless technology which has been tested and found to be compliant with the applicable regulations governing a radio transmitter in the 2.400GHz to 2.4835GHz frequency range.

NOTE: This equipment has been tested and found to comply with the limits for a Class B digital device, pursuant to part 15 of the FCC Rules. These limits are designed to provide reasonable protection against harmful interference

in a residential installation. This equipment generates, uses and can radiate radio frequency energy and, if not installed and used in accordance with the instructions, may cause harmful interference to radio communications. However, there is no guarantee that interference will not occur in a particular installation. If this equipment does cause harmful interference to radio or television reception, which can be determined by turning the equipment off and on, the user is encouraged to try to correct the interference by one or more of the following measures:

- Reorient or relocate the receiving antenna.
- Increase the separation between the equipment and receiver.
- Connect the equipment into an outlet on a circuit different from that to which the receiver is connected.
- Consult the dealer or an experienced radio/TV technician for help.

*Horizon Hobby, LLC
4105 Fieldstone Rd.
Champaign, IL 61822
Email: compliance@horizonhobby.com
Web: HorizonHobby.com*

IC Information

IC: CAN ICES-3 (B)/NMB-3(B)

IC (Transmitter): 6175A-BRDXMT

IC (Aircraft): 6157A-BLH9706

This device complies with Industry Canada license-exempt RSS standard(s). Operation is subject to the following two conditions:

(1) this device may not cause interference, and (2) this device must accept any interference, including interference that may cause undesired operation of the device.

Compliance Information for the European Union

CE **EU Compliance Statement:**
BLH8300: Horizon Hobby, LLC hereby declares that this product is in compliance with the essential requirements and other relevant provisions of the RED and EMC Directives.

BLH8380: Horizon Hobby, LLC hereby declares that this product is in compliance with the essential requirements and other relevant provisions of the RED and EMC Directives. A copy of the EU Declaration of Conformity is available online at: <http://www.horizonhobby.com/content/support-render-compliance>.



Instructions for disposal of WEEE by users in the European Union

This product must not be disposed of with other waste. Instead, it is the user's responsibility to dispose of their waste equipment by handing it over to a designated collections point for the recycling of waste electrical and electronic equipment. The separate collection and recycling of your waste equipment at the time of disposal will help to conserve natural resources and make sure that it is recycled in a manner that protects human health and the environment. For more information about where you can drop off your waste equipment for recycling, please contact your local city office, your household waste disposal service or where you purchased the product.



E328

©2019 Horizon Hobby, LLC.

Blade, the Blade logo, Inductrix, BNF and Bind-N-Fly logo, E-flite, SAFE, the SAFE logo, DSM, DSM2, DSMX, ModelMatch and the Horizon Hobby logo are trademarks or registered trademarks of Horizon Hobby, LLC. The Spektrum trademark is used with permission of Bachmann Industries, Inc. Futaba is a registered trademark of Futaba Denshi Kogyo Kabushiki Kaisha Corporation of Japan. All other trademarks, service marks or logos are property of their respective owners.

Created 12/18

60431.1

BLH8300 / BLH8380