

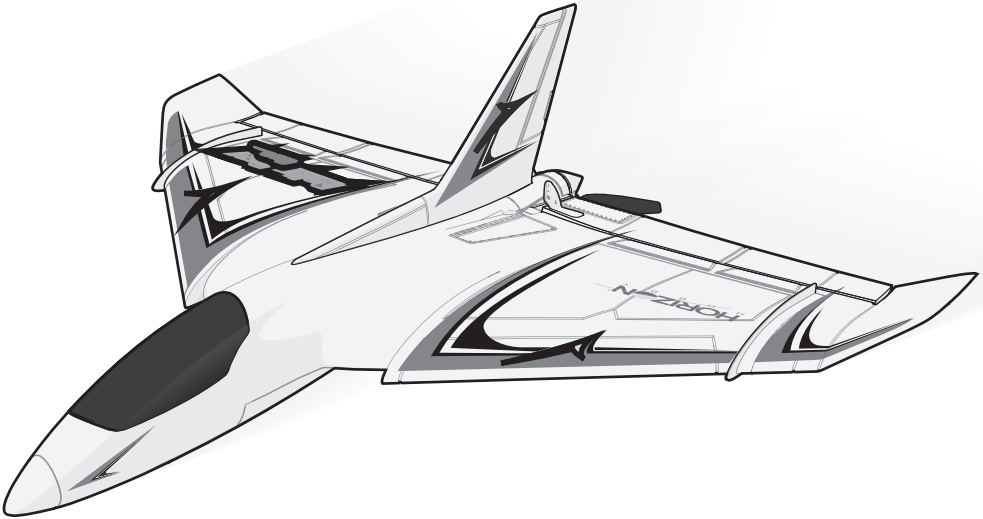

**SAFE<sup>®</sup>**   
SAFE<sup>®</sup> Technology, Optional Flight Envelope Protection

# ***Delta Ray<sup>®</sup>*** ***One***



***Instruction Manual***  
***Bedienungsanleitung***  
***Manuel d'utilisation***  
***Manuale di Istruzioni***

**RTF**  
READY-TO-FLY

**Bind-N-Fly<sup>®</sup>**  
BASIC

**NOTICE**

All instructions, warranties and other collateral documents are subject to change at the sole discretion of Horizon Hobby, LLC. For up-to-date product literature, visit [www.horizonhobby.com](http://www.horizonhobby.com) and click on the support tab for this product.

**Meaning of Special Language:**

The following terms are used throughout the product literature to indicate various levels of potential harm when operating this product:

**WARNING:** Procedures, which if not properly followed, create the probability of property damage, collateral damage, and serious injury OR create a high probability of superficial injury.

**CAUTION:** Procedures, which if not properly followed, create the probability of physical property damage AND a possibility of serious injury.

**NOTICE:** Procedures, which if not properly followed, create a possibility of physical property damage AND little or no possibility of injury.



**WARNING:** Read the ENTIRE instruction manual to become familiar with the features of the product before operating. Failure to operate the product correctly can result in damage to the product, personal property and cause serious injury.

This is a sophisticated hobby product. It must be operated with caution and common sense and requires some basic mechanical ability. Failure to operate this product in a safe and responsible manner could result in injury or damage to the product or other property. This product is not intended for use by children without direct adult supervision. Do not use with incompatible components or alter this product in any way outside of the instructions provided by Horizon Hobby, LLC. This manual contains instructions for safety, operation and maintenance. It is essential to read and follow all the instructions and warnings in the manual, prior to assembly, setup or use, in order to operate correctly and avoid damage or serious injury.

**Age Recommendation: Not for children under 14 years. This is not a toy.**

**Safety Precautions and Warnings**

- Always keep a safe distance in all directions around your model to avoid collisions or injury. This model is controlled by a radio signal subject to interference from many sources outside your control. Interference can cause momentary loss of control.
- Always operate your model in open spaces away from full-size vehicles, traffic and people.
- Always carefully follow the directions and warnings for this and any optional support equipment (chargers, rechargeable battery packs, etc.).
- Always keep all chemicals, small parts and anything electrical out of the reach of children.
- Always avoid water exposure to all equipment not specifically designed and protected for this purpose. Moisture causes damage to electronics.
- Never place any portion of the model in your mouth as it could cause serious injury or even death.
- Never operate your model with low transmitter batteries.
- Always keep aircraft in sight and under control.
- Always use fully charged batteries.
- Always keep the transmitter powered on while aircraft is powered.
- Always remove batteries before disassembly.
- Always keep moving parts clean.
- Always keep parts dry.
- Always let parts cool after use before touching.
- Always remove batteries after use.
- Always ensure failsafe is properly set before flying.
- Never operate aircraft with damaged wiring.
- Never touch moving parts.

## Table of Contents

SAFE® Technology .....	1	Landing .....	15
Table of Contents .....	3	After Flying .....	16
Specifications .....	3	Settings for Control Horns .....	16
Introduction- SAFE Technology out of the box .....	4	Motor Service .....	17
Optional Upgrades ( <i>not included</i> ) .....	4	Troubleshooting Guide (SAFE®) <i>without GPS</i> .....	18
From the Box to the Air ( <i>No GPS Module</i> ) .....	4	Adding the SAFE+ GPS Module .....	20
Included in the Box .....	4	GPS module installation: .....	20
Charging Warnings .....	5	Compass Calibration .....	22
Charging the Flight Battery .....	5	Flight Modes .....	23
Transmitter Batteries Installation .....	6	Flying the Delta Ray One with SAFE+ .....	23
Transmitter .....	6	In-Flight GPS OFF .....	23
BNF AIRCRAFT ONLY .....	7	Virtual Fence Mode and GPS .....	24
Binding .....	8	Holding Pattern (HP) .....	26
Install the Flight Battery .....	9	AutoLand (AL) .....	27
SAFE® Technology Flight Modes .....	10	Powering On with GPS .....	28
Control Direction Test .....	11	GPS Initialization and Home Location .....	28
SAFE® Control Direction Test .....	12	Disabling GPS .....	29
Choose a Flying Field .....	12	Troubleshooting Guide (SAFE® Plus) .....	29
Range Test ( <i>BNF Only</i> ) .....	13	FPV Camera with OSD .....	30
Takeoff .....	14	FPV features with the GPS module installed .....	31
Flying .....	14	Limited Warranty .....	33
Low Voltage Cutoff (LVC) .....	14	Replacement Parts .....	136
Adjusting Trim in Flight .....	15	Optional Parts .....	137



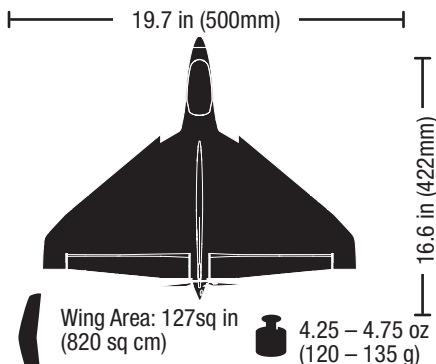



## Specifications



### RECEIVER BIND INFORMATION

Channels	6
Frequency	2405 – 2476 MHz
Compatibility	DSM2 and DSMX

<https://www.horizonhobby.com/content/e-flite-rc>

		RTF READY-TO-FLY	BNF BASIC
	<b>Motor:</b> BL180 Brushless Outrunner Motor	Installed	Installed
	<b>Receiver/ESC:</b> DSMX® /DSM2® RX/ ESC unit: Delta Ray One	Installed	Installed
	<b>Servos:</b> (2) Integrated Linear Servos	Installed	Installed
	<b>Battery:</b> 280mAh 2S 7.4V 30C Li-Po	Included	Required to Complete
	<b>Battery Charger:</b> Celectra™ 2S 7.4V Li-Po Charger	Included	Required to Complete
	<b>AC adapter</b>	Included	Required to Complete
	<b>Transmitter:</b> DSM2/DSMX Transmitter	Included	Required to Complete

## Included in the Box

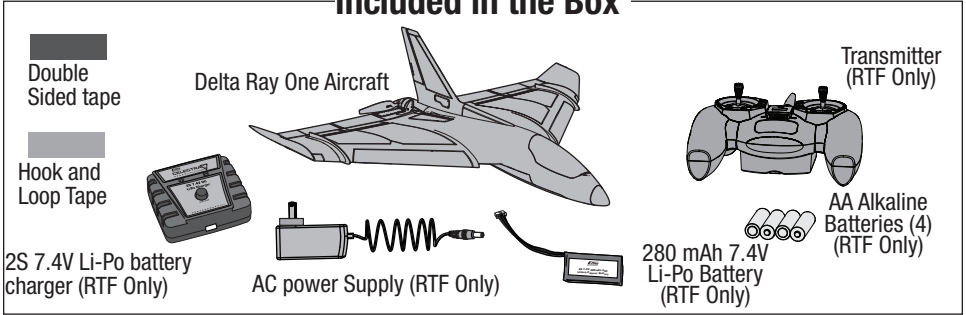

## Introduction- SAFE Technology out of the box

The E-flite® Delta Ray® One airplane is an exceptional trainer that's a blast to fly. At its heart is groundbreaking SAFE™ (Sensor Assisted Flight Envelope) technology that makes RC flight incredibly easy, even for the least experienced user. Its combination of spatial awareness provides flight envelope protection which adds a degree of security never before available, while it's smooth flight capability battles windy conditions so that all you feel is control that's crisp and responsive. Multiple levels of flight envelope protection are provided that can be reduced or removed as your skills progress, yet can be changed at the flip of a switch if needed to instantly return the model to level flight if you ever lose orientation.

### Optional Upgrades *(not included)*

SAFE+ GPS Module	FPV Camera w/5.8GHz vtx
When added, advanced SAFE+ features can keep the aircraft within a given distance to the pilot (Virtual Fence), can return the model to home at the press of a button (Holding Pattern), can return home automatically if the controller signal is lost (Failsafe), and can land itself when commanded (AutoLand).	Adding the FPV camera shows information from the aircraft in the video image with an On Screen Display (OSD). With the GPS module and the FPV camera, the GPS information provides additional features for the On Screen Display.

## From the Box to the Air *(No GPS Module)*

✓	
	1. Charge flight battery.
	2. Set up your transmitter (BNF only).
	3. Find a safe and open area.
	4. Power on transmitter and install flight battery in aircraft.
	5. Place the aircraft into Experienced mode (Mode switch position 2) for the control direction test. Place the aircraft on the ground facing away from you.
	6. Perform Control Direction Test.

✓	
	7. Place the aircraft into <b>Beginner Mode</b> (Mode switch position 0) for the SAFE Control Direction Test and takeoff.
	8. Perform SAFE Control Direction Test.
	9. Plan flight for flying field conditions.
	10. Set a flight timer for 6 minutes.
	11. Place the aircraft into <b>Beginner Mode</b> for launch.
	12. Launch into the wind and have fun!

## Charging Warnings

The included (RTF Only) battery charger (EFLUC1007) has been designed to safely charge the Li-Po battery.

**CAUTION:** All instructions and warnings must be followed exactly. Mishandling of Li-Po batteries can result in a fire, personal injury and/or property damage.

- **Never charge batteries overnight.**
- **Never leave charging batteries unattended.**
- By handling, charging or using the included Li-Po battery, you assume all risks associated with lithium batteries.
- If at any time the battery begins to balloon or swell, discontinue use immediately. If charging or discharging, discontinue and disconnect. Continuing to use, charge or discharge a battery that is ballooning or swelling can result in fire.
- Always store the battery at room temperature in a dry area for best results.
- Always transport or temporarily store the battery in a temperature range of 40–120° F. Do not store the battery or model in a car or direct sunlight. If stored in a hot car, the battery can be damaged or

even catch fire.

- Always charge batteries away from flammable materials.
- Always inspect the battery before charging.
- Always disconnect the battery after charging, and let the charger cool between charges.
- Always constantly monitor the temperature of the battery pack while charging.
- **ONLY USE A CHARGER SPECIFICALLY DESIGNED TO CHARGE LI-PO BATTERIES.** Failure to charge the battery with a compatible charger may cause a fire resulting in personal injury and/or property damage.
- Never discharge Li-Po cells to below 3V under load.
- Never cover warning labels with hook and loop strips.
- Never charge batteries outside recommended levels.
- Never charge damaged batteries.
- Never attempt to dismantle or alter the charger.
- Never allow minors to charge battery packs.
- Never charge batteries in extremely hot or cold places (recommended between 40–120° F or 5–49° C) or place in direct sunlight.

## Charging the Flight Battery

The RTF aircraft comes with a 2S 7.4V 280mAh 30C Li-Po battery and a 2S 7.4V Li-Po battery charger that requires use of the included (RTF Only) AC power supply or the optional 12V (11V–14V) DC power cord (EFLUC1008).

Refer to the charging warnings. It is recommended to charge the battery pack while you are inspecting the aircraft. The flight battery will be required to confirm proper aircraft operation in future steps.

### Battery Charging Process

**NOTICE:** Charge only batteries that are cool to the touch and are not damaged. Look at the battery to make sure it is not damaged e.g., swollen, bent, broken or punctured.

1. Gently press the battery connector into the charge port located on the front of the charger. The connector of the battery is specifically designed to allow it to fit into the charge port one way to prevent reverse polarity connection. However, check for proper alignment and polarity.
2. Press the button on the charger. The red LED will illuminate, indicating charging has begun.

Charging a fully discharged (not over-discharged) 280mAh battery takes approximately **45 minutes** at the charger's 300mA charge rate. The included battery can be charged at a rate of up to 3C (840mA).

Always disconnect the flight battery from the charger immediately upon completion of charging.

### LED Indications

1. Green LED blinking ..... Standby
2. Blinking Red LED at varying speeds.... Charging
3. Red and Green LED blinking simultaneously ..... Balancing
4. Solid Green LED ..... Full Charge
5. Red and Green LED flashing rapidly .... Error

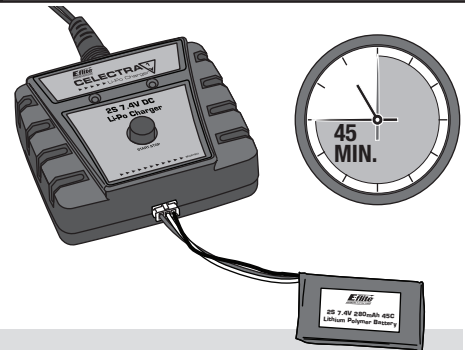

**CAUTION:** Overcharging a battery can cause a fire.

**CAUTION:** Only use a charger specifically designed to charge this Li-Po battery. Failure to do so could result in fire, causing injury or property damage.

**CAUTION:** Never exceed the recommended charge rate.

# RTF Transmitter

READY-TO-FLY

## Low Battery Alarm

When the battery voltage drops too low, an alarm sounds and the LED flashes. The batteries must be replaced immediately. If this happens while flying, land your aircraft as soon and as safely as possible.

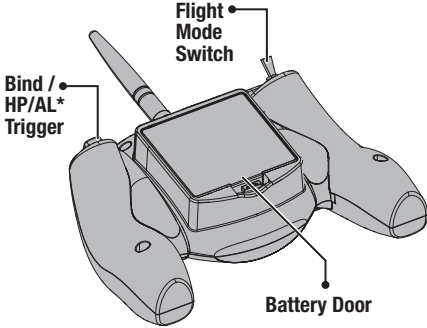

\* (HP) = Holding Pattern (AL) = AutoLand  
Holding pattern and Autoland are only available with the optional GPS module

The included transmitter comes pre-bound to the aircraft.

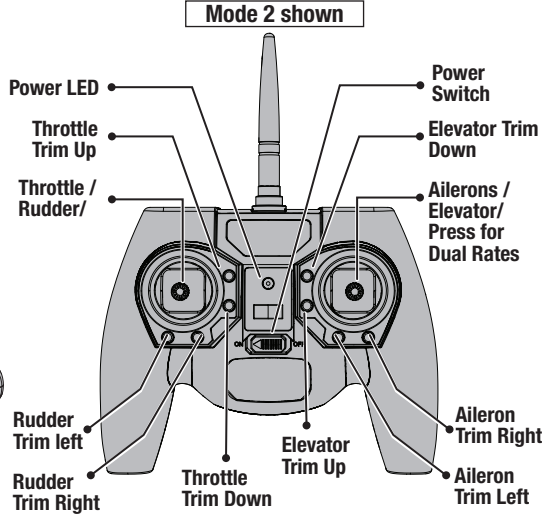

## Dual Rates

The included DSMX® transmitter features dual rates to allow you to select the amount of travel that you want from the control surfaces. Press the Aileron/Elevator stick into the transmitter to change between low rate and high rate mode for elevator and aileron. Low Rate is indicated by the Power LED flashing, on High Rate the LED will be solid.

Dual Rate	High Rate	Low Rate
Aileron	100%	70%
Elevator	100%	70%

## Transmitter Batteries Installation

Remove the battery cover. Install the four included batteries (noting proper polarity) and reinstall the battery cover.

- CAUTION:** NEVER remove the transmitter batteries while the model is powered on. Loss of model control, damage or injury may occur.
- CAUTION:** If using rechargeable batteries, charge only rechargeable batteries. Charging non-rechargeable batteries may cause the batteries to burst, resulting in injury to persons and/or damage to property.
- CAUTION:** Risk of explosion if battery is replaced by an incorrect type. Dispose of used batteries according to national regulations.

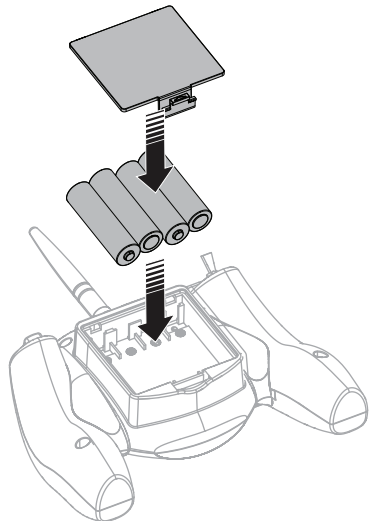



**Transmitter Setup**

**IMPORTANT:** The installed receiver has been programmed for operation specifically in this aircraft.

To operate the SAFE® or SAFE® Plus (optional) system in this aircraft, set up your optional DSMX®/DSM2® transmitter using the chart below.

- SAFE Flight mode is selected using the B Switch (Gear/ Ch 5)
- Holding Pattern and AutoLand are selected using Button I\* (Aux1/ Ch6)

**IMPORTANT:** A transmitter with a 2-position Channel 5 switch will only allow the use of position 0 (Beginner Mode) or position 2 (Experienced Mode) flight modes. If possible assign Channel 5 in your transmitter to a 3-position switch to operate all 3 flight modes (refer to your transmitter's manual).

Refer to your transmitter's manual for more information about transmitter setup.

\*Holding pattern and Autoland are only available with the optional GPS module

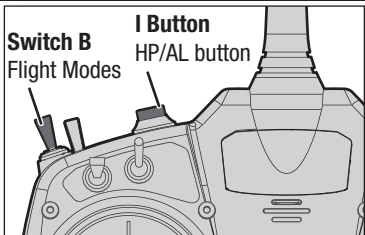
<b>Computerized Transmitter Setup</b>	
Start all transmitter programming with a blank model setup (do a model reset), then name the model.	
Set Aileron and Elevator Rates to:	HIGH 100% LOW 70%
DX6e DX6 DX7 (Gen2) DX8e DX8 (Gen2) DX9 DX18 DX20	1. Go to the SYSTEM SETUP
	2. Set MODEL TYPE: AIRPLANE
	3. Go to CHANNEL ASSIGN: click NEXT to go to Channel Input Config: GEAR: B, AUX1: I
	4. Go to the FUNCTION LIST
	5. Go to throttle cut: Assign the switch to the H switch Set the cut off position to -130%
iX12	1. Touch the Model Setup tab from the main screen
	2. Select Channel Assign; Assign Gear (5) to Switch B Assign Aux1 (6) to Switch I
	3. Exit back to the main screen
	4. Touch the Model Adjust tab from the main screen.
	5. Select Throttle Cut: Assign the switch to the H switch Set the cut off position to -130%
Resulting in:	<div style="display: flex; justify-content: space-around;"> <div> <p><b>Switch B</b> Flight Modes</p> </div> <div> <p><b>I Button</b> HP/AL button</p> </div> </div>  <p><b>Switch B</b> operates the 3 SAFE Plus modes (0 beginner/1 intermediate/2 experienced) <b>Button I</b> commands Holding Pattern/Autoland*</p>

## Binding



### Re-Binding the RTF Transmitter

Your Delta Ray One RTF transmitter comes pre-bound to the aircraft. If you ever need to re-bind your aircraft, follow this binding table.

#### Binding Procedure *Without optional GPS*

1. Make sure the flight battery is disconnected from the aircraft.
2. Ensure the transmitter is powered OFF.
3. Connect the flight battery to the aircraft and set the aircraft on the ground. After five seconds the aircraft will enter bind mode, as indicated by red and green LEDs flashing rapidly on the receiver.
4. Make sure the transmitter controls and trims are at neutral and the throttle is in the low position.
5. Put your transmitter into bind mode by holding the red HP/AL button while powering ON the transmitter, after two seconds release the button.
6. After five to ten seconds, the elevons will cycle to indicate the bind is complete, and then return to center. Move the controls to confirm operation.
7. Disconnect the flight battery and power the transmitter off.

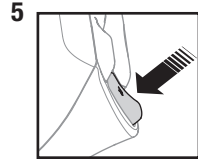
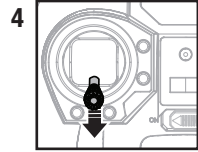

For subsequent flights, power on the transmitter for five seconds before connecting the flight battery.

#### Binding Your Optional Transmitter



For a list of compatible DSMX®/DSM2® transmitters, please visit [www.bindnfly.com](http://www.bindnfly.com). For more details on how to bind your transmitter, see the manual for your transmitter.

#### Binding Procedure *Without optional GPS*

Refer to your transmitter's unique instructions for binding to a receiver.

1. Make sure the flight battery is disconnected from the aircraft.
2. Prepare you transmitter for binding according to its manual
3. Connect the flight battery to the aircraft set the aircraft on the ground. After five seconds the aircraft will enter bind mode, as indicated by red and green LEDs flashing rapidly on the receiver.
4. Make sure the transmitter controls and trims are at neutral and the throttle is in the low position.
5. Put your transmitter into bind mode.
6. After five to ten seconds, the elevons will cycle to indicate the bind is complete, and then return to center. Move the controls to confirm operation.
7. Disconnect the flight battery and power off the transmitter RF output.

For subsequent flights, power on the transmitter RF output for five seconds before connecting the flight battery.

### Applies only when the optional GPS module is installed

**IMPORTANT: IF THE OPTIONAL GPS MODULE IS INSTALLED** the aircraft will not respond to transmitter commands after binding if it cannot acquire a GPS signal. To test or fly the model indoors, you must disable the GPS, see the Disable GPS section later in this manual.

If the GPS module is connected, the GPS must be disabled every time the aircraft is powered on in order to operate the model without a GPS signal.

**Binding:** After binding with the GPS module installed, the aircraft will search for a GPS lock, indicated by the elevons slowly cycling up and down. After acquiring a GPS lock, the home position must be set. See the Powering On With GPS section of this manual for further details.

**Compass calibration:** After binding the first time with the GPS module installed in the aircraft, compass calibration is required. The aircraft will automatically enter the compass calibration sequence after installing the GPS for the first time. This is indicated by the elevons slowly cycling opposite up and down. The aircraft will not respond to transmitter commands with the GPS module installed until calibration has been completed. See the Compass Calibration section of this manual for further details.

Subsequent binding with the GPS module will not require compass calibration.



## Install the Flight Battery

### Battery Selection

- The E-flite® 280mAh 7.4V 2S 30C Li-Po battery (EFLB2802S30) is recommend.
- We recommend only using the suggested battery for proper performance.

1. Lower the throttle stick to the lowest setting and center the throttle trim with your transmitter powered on.
2. Apply a strip of hook tape to the battery.
3. Open the battery hatch.
4. Install the flight battery as shown and verify the CG before flight. Move the battery fore or aft as necessary to achieve the recommended CG.
5. Connect the battery to the ESC. Close the hatch and place the aircraft on the ground. Keep the aircraft immobile and away from wind for 5 seconds.
6. When the flight control system has completed initialization, it will make several tones from the motor, cycle the elevons up and down, and then make several more tones from the motor to indicate the model is ready to operate.

### Side view of battery placement (without GPS module)

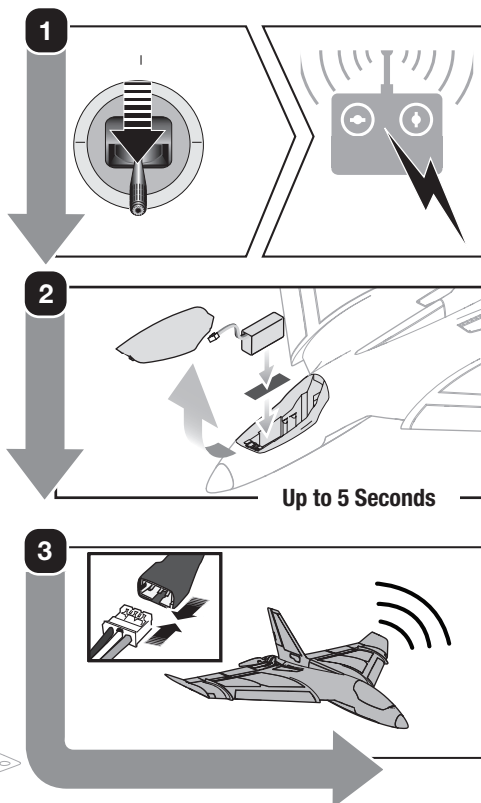
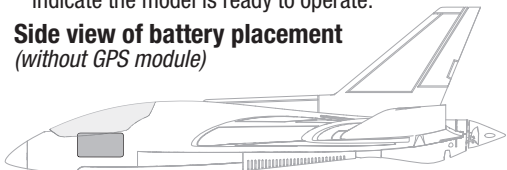

- CAUTION:** Always disconnect the Li-Po flight battery from the aircraft when not flying to avoid over-discharging the battery. Batteries discharged to a voltage lower than the lowest approved voltage may become damaged, resulting in loss of performance and potential fire when batteries are charged.
- CAUTION:** Always keep hands away from the propeller and fully lower the throttle and throttle trim. When armed, the motor will turn the propeller in response to any throttle movement.

### Center of Gravity (CG)

Measure back 60 – 68mm from the break in the leading edge of the wing, and place a mark. With the battery installed, balance the aircraft within this CG range.

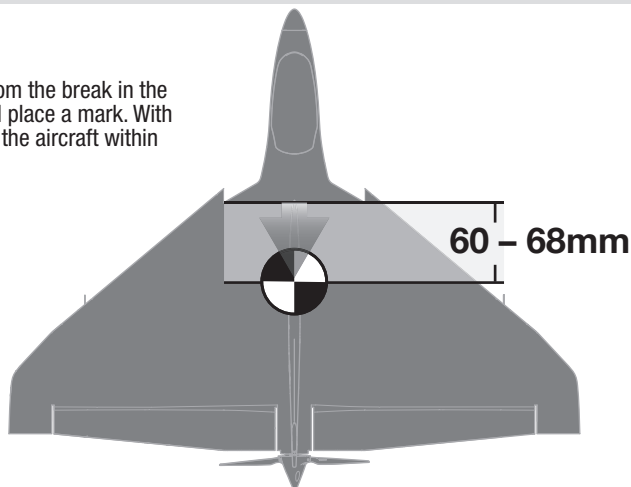

## SAFE® Technology Flight Modes

### Three position flight mode switch

The three position switch on the upper left hand corner of the RTF transmitter controls the flight mode. The “B” switch controls the flight mode for BNF aircraft, when using the transmitter settings recommended in this manual.

#### Flight Mode Switch

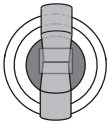

#### Switch Position

0 (away from pilot)

1 (middle)

2 (toward pilot)

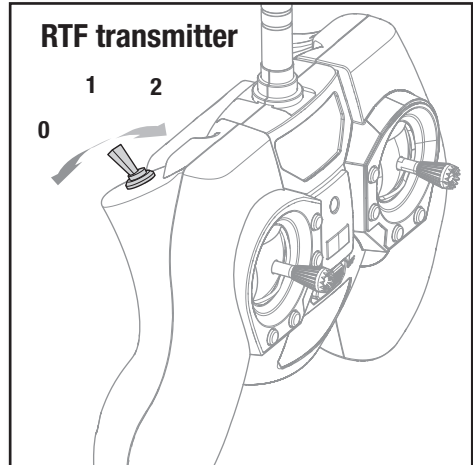

#### Beginner Mode (Pos 0):

- Below approx. 46 feet (14m), pitch (nose up and down) and roll (wing tips up and down) angles are limited to help you keep the aircraft airborne.
- Above approximately 46 feet (14m), pitch and roll control are increased slightly.
- At any time release both sticks to activate panic recovery mode for self-leveling.



Beginner Mode  
(Switch Position 0)

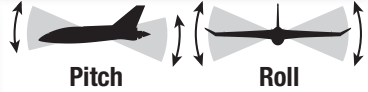

#### Intermediate Mode (Pos 1):

- Same as beginner mode, Self leveling below approximately 46 feet (14m).
- Above 46 feet (14m) self leveling is not active. Pitch and Roll control angles are higher



Intermediate Mode  
(Switch Position 1)

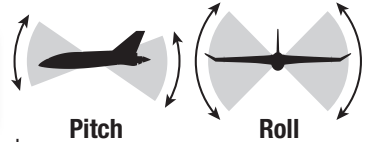

#### Experienced Mode (Pos 2):

- Unlimited Flight Envelope.
- It is recommended when using the RTF transmitter to use low rates for the first few flights in experienced mode or until you become familiar with the flight performance of the Delta Ray One.
- Switch to beginner mode at any time and release the control sticks for self-leveling.



Experienced Mode  
(Switch Position 2)

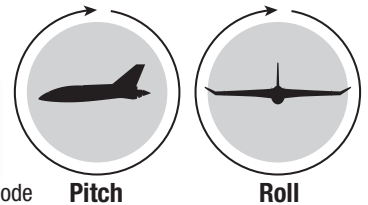

**NOTICE:** If the aircraft is upside down when the self leveling is applied, sufficient altitude is required for the aircraft to return to straight and level flight.

#### Holding Pattern and AutoLand:\*

Inoperable without the GPS module. Move the flight mode switch to the beginner position if you feel you have lost control.

Holding pattern and Autoland are only available with the optional GPS module, see adding the optional GPS section later in this manual for more details.

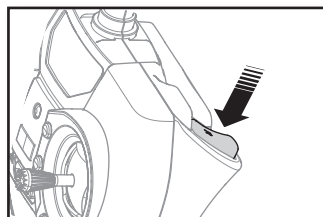

**The first few times trying experienced mode it is suggested to use low rates**

## Control Direction Test

1. Place the aircraft into **Experienced mode** (Mode switch position 2).
2. Place the aircraft on the ground facing away from you.
3. Move the sticks on the transmitter to ensure the aircraft responds as shown.
4. If the aircraft responds as shown, move the SAFE® mode switch to **Beginner mode** (Position 0) to prepare to fly.

Refer to the Binding instructions and Troubleshooting Guide in this manual for more information. If you need more assistance, contact the appropriate Horizon Hobby Product Support department.

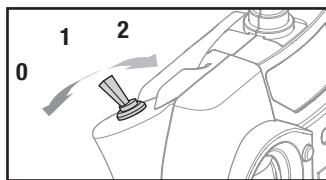

Experienced Mode  
(Switch Position 2)

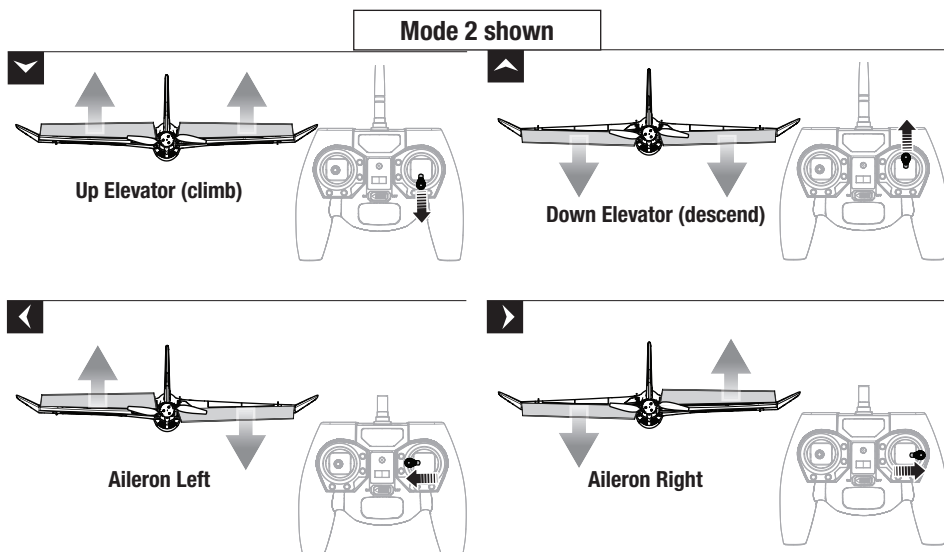

## SAFE® Control Direction Test

Perform the Control Direction Test in beginner mode to ensure the aircraft responds correctly to your transmitter. Once you are sure the aircraft responds correctly, stay clear of the prop, run the motor briefly to above half power or more. Shut the motor back off and confirm the throttle stick is in the lowest position.

Change to beginner mode. Move the aircraft as shown to ensure the SAFE system moves the control surfaces in their proper direction. If the control surfaces do not respond as shown, do not fly the aircraft. Contact Horizon Hobby Product Support.

The SAFE system will not activate until the throttle stick or trim is increased for the first time after the flight battery is connected. Once the SAFE is active, the control surfaces may move on the aircraft. This is normal. SAFE will remain active until the battery is disconnected.

	Aircraft movement	SAFE Reaction
Elevator		
Aileron		

## Choose a Flying Field

**Consult local laws and ordinances before choosing a location to fly your aircraft.**

In order to have the most success and to protect your property and aircraft, it is very important to select a place to fly that is very open.

Remember, your aircraft can reach significant speeds when flying and can cover ground quickly. Plan on flying in an area that gives you more space than you think you need, especially with first flights.

### The site should:

- Have a minimum of approximately 1300 feet (400m) of clear space in all directions.
- Be clear of people and pets.
- Be free of trees, buildings, cars, power lines or anything that could entangle your aircraft or interfere with your line of sight.

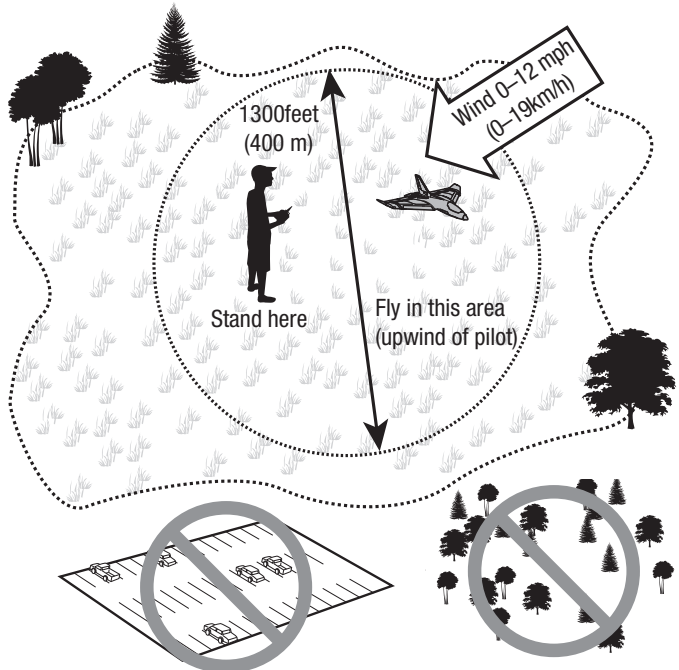

## Takeoff

### Hand Launch

Use the Beginner mode for launching the aircraft.

Get help to hand launch your aircraft for the first few flights so you can concentrate on flying. If you must hand launch the aircraft alone, hold the Aircraft in your dominant hand and the transmitter in your other hand.

Low rate is recommended for the first few flights.

1. Hold the aircraft from the wing tip.
2. Advance the throttle to full power.
3. Gently toss the airplane at a slightly upward angle into the wind.

**IMPORTANT:** Think of the launch as placing the model into the air. Launching hard is not necessary.

Turn the aircraft only after it is flying at a comfortable altitude above the ground.

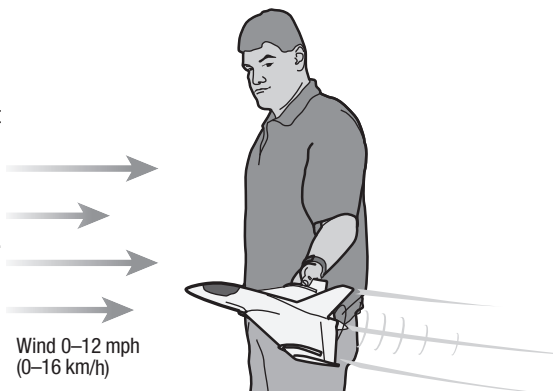

Climbs at 100% throttle.

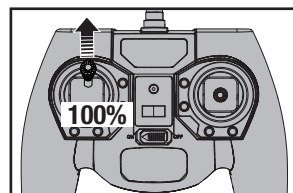

## Flying

In Beginner mode, when properly trimmed, your aircraft will climb at full throttle without use of the elevator stick. The climb angle will be steeper until it reaches approximately 46 feet (14m) of altitude and then will reduce slightly.

- Set a flight timer for 6 minutes.
- If the motor pulses, land the aircraft immediately and recharge the flight battery.
- Flying with the nose pointed toward you is one of the hardest things to do when learning to fly. To practice piloting the aircraft, try flying in large circles high off the ground.

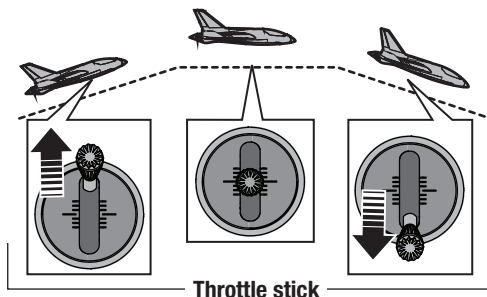

## Low Voltage Cutoff (LVC)

LVC is a built in feature to protect the battery from over-discharge. When the battery charge is too low, LVC limits power supplied to the motor. The aircraft will begin to slow and you will hear the motor pulse.

When the motor power decreases, land the aircraft immediately and recharge the flight battery.

Disconnect and remove the Li-Po battery from the aircraft after use to prevent trickle discharge. Charge your Li-Po battery to about half capacity before storage. During storage, make sure the battery charge does not fall below 3V per cell.

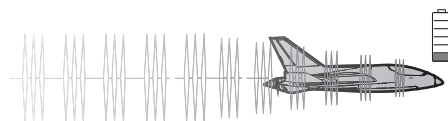

**NOTICE:** Repeated flying to LVC will damage the battery. It is important to set a flight timer to end your flight before you hit LVC.

## Adjusting Trim in Flight

Familiarize yourself with your transmitter's controls and the aircraft's response before flying by performing the recommended Control Direction Test. Press the trim buttons on your transmitter to adjust how the aircraft flies.

If the aircraft's nose drifts while the sticks are at neutral (centered) and the throttle is at 50%, press the trim buttons:







- Upper button to stop up drift
- Lower button to stop down drift
- Left button to stop right roll
- Right button to stop left roll

If you press a trim button until it makes a rapid beeping sound and the aircraft does not fly straight and level, land manually and adjust the trim as described below.

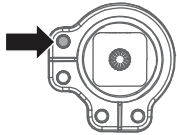
### Manually Adjusting Trim

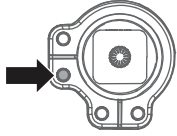
Only adjust the pushrods immediately after powering the aircraft on, before advancing the throttle. This lets you make changes before SAFE has been activated when the control surfaces are not moving from SAFE corrections.

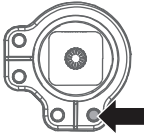
1. After making trim changes in flight, visually note the required trim.
2. Re-center the transmitter trim.
3. Use a pair of pliers to carefully bend the metal U-Bend to shorten or lengthen the pushrods to the desired length:

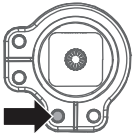
Direction of Drift	Button to Correct
	
	
	
	

**IMPORTANT:** Make all trim changes in experienced mode.

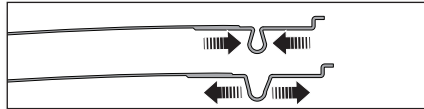

## Landing

1. Reduce the throttle to around 50% to slow the airspeed.
2. Fly the aircraft downwind past the end of the runway.
3. Turn the aircraft into the wind and line the aircraft up with the runway center line.
4. Decrease the throttle further and begin descending towards the runway, keeping the wings level during approach. Try to have the aircraft at 10ft altitude as it passes over the threshold of the runway.
5. As the aircraft passes over the threshold of the runway decrease the throttle fully.
6. Just as the aircraft is about to touch down, gently pull back on the elevator to raise the nose and flair for a gentle landing.

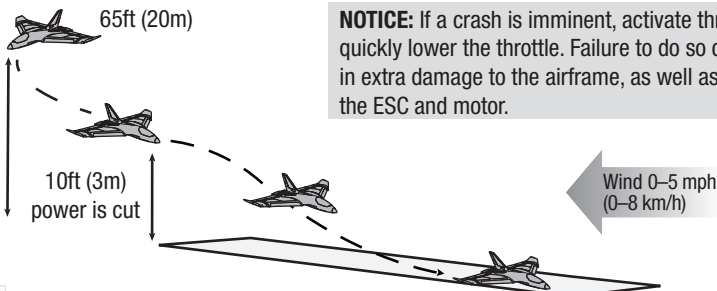

**NOTICE:** If a crash is imminent, activate throttle hold or quickly lower the throttle. Failure to do so could result in extra damage to the airframe, as well as damage to the ESC and motor.

## After Flying

1. Lower the throttle stick completely. Wait at least five seconds.
2. Disconnect and remove the battery from the aircraft. Keep hands away from the propeller.
3. Power off the transmitter.
4. Fully charge the aircraft battery.
5. Remove the battery after charging is complete.

**NOTICE:** When you are finished flying, never leave the aircraft in direct sunlight or in a hot, enclosed area such as a car. Doing so can damage the foam.

**NOTICE:** Always disconnect the battery from the aircraft before powering off the transmitter or injury and damage may result.

## Repairs

Repair this aircraft using CA (cyanoacrylate adhesive) glue or clear tape. When parts are not repairable, see the Replacement Parts List for ordering by item number.

For a listing of all replacement and optional parts, refer to the list at the back of this manual.

1

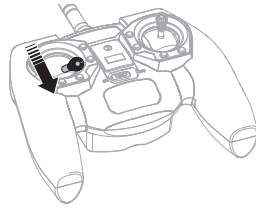

2

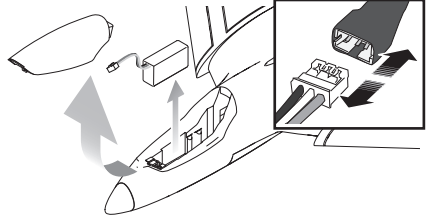

3

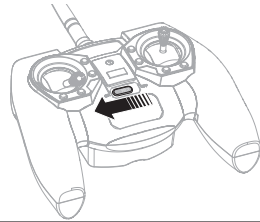

4

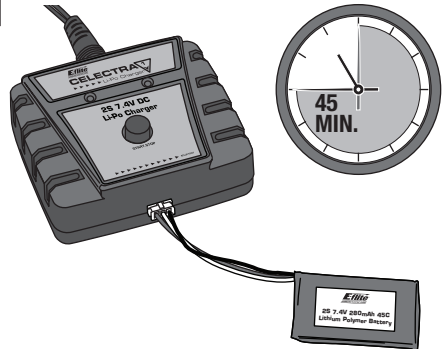

## Settings for Control Horns

The illustration shows factory settings for linkages on the control horns.

**CAUTION:** The SAFE flight control system has been tuned to operate in the control horn position as shown. Do not adjust the control horn or loss of control and/or a crash may occur.

Elevons

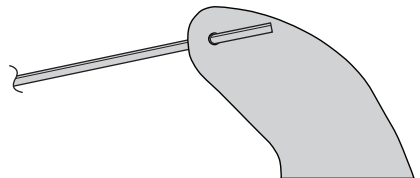

## Motor Service

### Disassembly

**CAUTION:** DO NOT handle the propeller while the flight battery is connected to the ESC. Personal injury could result.

Disconnect the battery.

1. Remove the four screws from the bottom of the airframe holding the motor cover in place.
2. Disconnect the motor wire connector from the ESC/receiver connector.
3. Remove the screw from the motor mount, and remove the motor.
4. Remove the three screws holding the spinner and folding propeller assembly on the motor.

### Assembly

Assemble in reverse order.

- Ensure the folding propeller assembly and the motor is secured in the motor mount.
- Connect the motor wire connector to the ESC/receiver.
- Ensure the screws holding the motor cover/motor mount assembly are secured to the airframe.

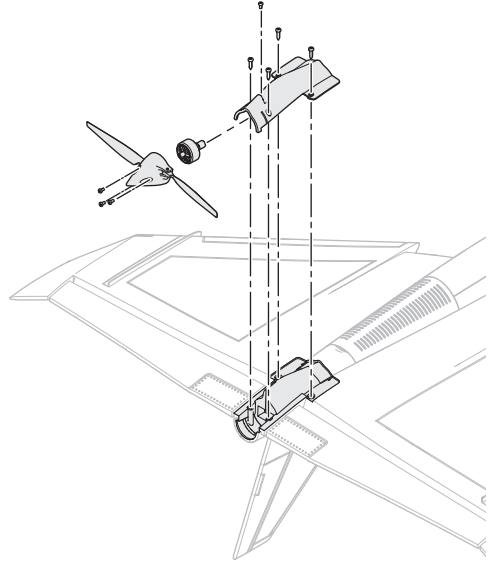

## RTF Transmitter Range

The MLP6 Transmitter included with the RTF combo is low powered and has a limited range of approximately 100 meters, depending on the environment.

Range may be affected by;

- Pointing the transmitter antenna at the model
- Sitting while flying and having the antenna close to the ground
- Flying behind your body
- Flying low, far, or behind objects
- RF noise such as congested areas inundated with WiFi
- Operating near metal structures
- Rain, mist or fog

For optimal control link performance operate the aircraft in an open area away from large metal structures, stand while flying and avoid pointing the transmitter antenna directly at the model. If the model stops responding to the controls, raise the transmitter over your head with the antenna pointed vertical to optimize the antenna location, and turn the model around when control is regained.

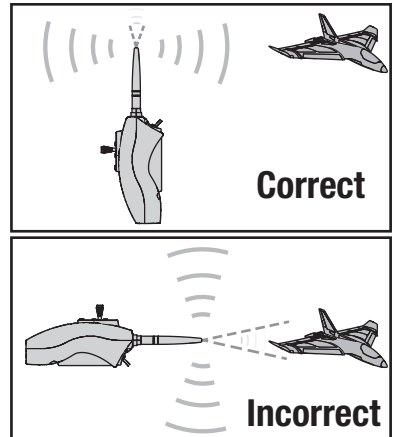

**CAUTION:** Do not point the transmitter antenna at the model. The area off the tip of the antenna is where the signal is the weakest (the null). If the transmitter antenna is pointed at the aircraft, range will be greatly shortened.



## Troubleshooting Guide (SAFE®) *without GPS*

Problem	Possible Cause	Solution
Control surfaces not at neutral position when transmitter controls are at neutral	Control surfaces may not have been mechanically centered from factory	Center control surfaces mechanically by adjusting the U-bends on control linkages
	Aircraft was moved after the flight battery was connected and before sensors initialized	Keep the Aircraft upright and immobile for 5 seconds after connecting the battery
	SAFE may be active and plane is not level	Normal operation, review the SAFE control direction test in this manual for more details
Aircraft flies inconsistently from flight to flight	Trims are moved too far from neutral position	Neutralize trims and mechanically adjust linkages to center control surfaces
Controls oscillate in flight, (Aircraft rapidly jumps or moves)	Propeller is unbalanced, causing excessive vibration	Remove propeller and rebalance or replace it if damaged
	The three spinner screws are loose, causing excessive vibration	Tighten spinner screws
	The motor screw in the bottom of the plane may be loose	Tighten motor screw
Aircraft does not connect to transmitter after battery is connected	Aircraft is not upright and immobile after battery is connected	Keep the Aircraft upright and immobile for 5 seconds after connecting the battery
	Aircraft was powered on before transmitter and entered bind mode	Power on the transmitter before the aircraft, except when binding

## Troubleshooting Guide *without GPS*

Problem	Possible Cause	Solution
Aircraft will not respond to throttle but responds to other controls	Throttle stick not lowered or and/or throttle trim not centered	Reset controls with throttle stick at lowest setting and throttle trim centered
	Throttle channel is reversed	Reverse throttle channel on transmitter
	Motor is disconnected from receiver	Open fuselage and ensure the plug for the motor is properly installed
	throttle cut active	deactivate throttle cut
Extra propeller noise or extra vibration	Damaged propeller, prop shaft or motor	Replace damaged parts
Reduced flight time or aircraft underpowered	Flight battery charge is low	Completely recharge flight battery
	Propeller is installed backwards	Install propeller with numbers facing forward
	Flight battery is damaged	Replace flight battery and follow flight battery instructions
	Flight conditions may be too cold	Make sure battery is warm before use
	Battery capacity is too low for flight conditions	Replace battery or use a larger capacity battery

## Troubleshooting Guide *without GPS*

Problem	Possible Cause	Solution
Aircraft does not connect to transmitter after battery is connected	Aircraft is not upright and immobile after battery is connected	Keep the Aircraft upright and immobile after connecting the battery
	Aircraft bound to different model memory (ModelMatch™ radios only)	Select correct model memory on transmitter and disconnect and reconnect flight battery to aircraft
	Flight battery/transmitter battery charge is too low	Replace/recharge batteries
	Transmitter may not be compatible with Spektrum DSMX/DSM2 technology	Use a genuine Spektrum DSMX/DSM2 transmitter
	Aircraft or transmitter is too close to large metal object, wireless source or another transmitter	Move aircraft and transmitter to another location and attempt linking again
Control surface does not move	Control surface, control horn, linkage or servo damage	Replace or repair damaged parts and adjust controls
	Wire damaged or connections loose	Do a check of wires and connections; connect or replace as needed
	Flight battery charge is low	Fully recharge flight battery
	Control linkage does not move freely	Make sure control linkage moves freely
Controls reversed	Transmitter settings reversed	Do the Control Direction Test and adjust controls on transmitter appropriately
Motor loses power	Damage to motor or power components	Do a check of motor and power components for damage (replace as needed)
Motor power pulses then loss of power	Battery power is down to the point of receiver/ESC Low Voltage Cutoff (LVC)	Recharge flight battery or replace battery that is no longer performing
Servo locks or freezes at full travel	Travel adjust value is set above 100% over-driving the servo	Set Travel adjust to 100% or less and/or set sub trims to Zero and adjust linkages mechanically
Aircraft suffers from short range	Heavy use of WiFi in the vicinity, large metal structures, concrete with rebar construction, etc, poor environment for rf.	Select a new location to fly
	Pointing the transmitter antenna at aircraft in flight	Don't point the transmitter at the aircraft in flight
	Sitting on the ground with the transmitter antenna close to the ground	Prevent the transmitter antenna from being next to the ground when flying
	Poor receiver antenna placement	Antenna should be located as far from metal objects as possible, and not folded or coiled
	Damaged receiver antenna	Replace the receiver

## Optional SAFE+ GPS Upgrade

# SAFE+<sup>®</sup> From the Box to the Air – Adding the SAFE+ GPS Module

The Delta Ray One receiver includes SAFE technology out of the box.

The Delta Ray One aircraft is upgradable with the addition of the optional EFL9512 GPS module (not included) which enables Advanced SAFE+ features. With SAFE+, the aircraft can fly a holding pattern on its own, return home and land by itself, and prevent the model from flying too far from the pilot.

**IMPORTANT:** Read the information in this manual covering the optional SAFE+ GPS upgrades, and learn the use of Holding Pattern and Autoland modes before flying with GPS. SAFE+ features are only available with the SAFE+ module installed and properly calibrated.

Follow the steps below to add SAFE+ functions to your aircraft.

✓	
	1. Charge the flight battery.
	2. Set up your transmitter (BNF only).
	3. Install the GPS module.*
	4. Find a safe and open area.
	5. Power the model on outdoors and perform the compass calibration.
	6. Unplug the battery after the compass calibration is complete.
	7. Power the model on and allow it to acquire a GPS lock. The elevons will move up and down as elevators until GPS lock is acquired, and then re-center.
	8. Set the home position (and flying field location for flying field mode).

✓	
	9. Place the aircraft into <b>Experienced mode</b> (Mode switch position 2) for the control direction test. Place the aircraft on the ground facing away from you.
	10. Perform Control Direction Test.
	11. Place the aircraft into <b>Beginner mode</b> (Mode switch position 0) and cycle the throttle to activate SAFE.
	12. Perform SAFE Control Direction Test.
	13. Plan flight for flying field conditions.
	14. Set a flight timer for 6 minutes.
	15. Have fun!

\*The GPS orientation is critical, see GPS module installation instructions for details.

### GPS MODULE INSTALLATION:

1. Verify the battery is not connected or installed in the aircraft.
2. Feed the cable from the GPS module into the back of the battery cavity, toward the center of the aircraft.
3. Flip the model over, open the magnetic cover, and pull the connector through to the center electronics bay.
4. Connect the cable from the GPS module with the GPS cable from the main receiver/ servo circuit board. Prevent the cables from interfering with the servo gears.

*Continued on next page*

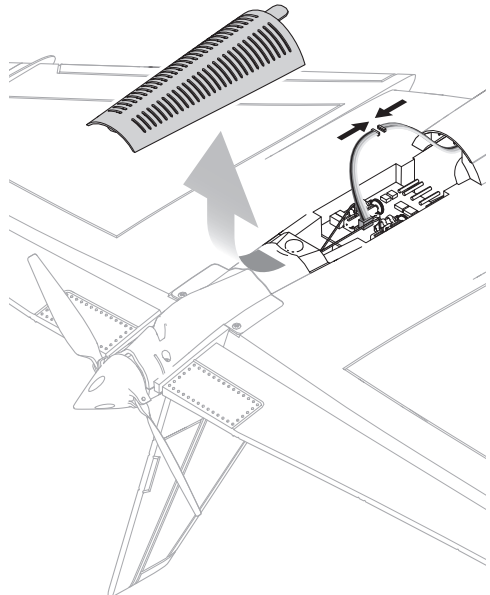
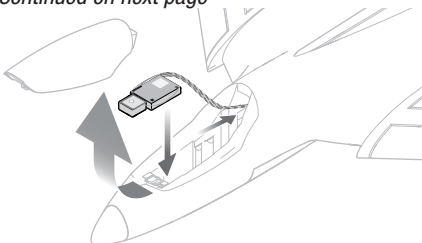

## Optional SAFE+ GPS Upgrade

### GPS MODULE INSTALLATION: *(continued)*

- Remove the piece of hook and loop tape applied to the bottom of the battery compartment from the factory.
- Apply a piece of double side tape on the bottom of the GPS circuit board and the GPS antenna.
- Mount the circuit board and antenna in the nose of the aircraft, as show below.
- Lay the wires into the channel in the bottom of the battery compartment, and apply the provided piece of adhesive backed hook and loop tape over the channel to hold them in place.
- With the GPS in the aircraft, install the battery further back for flight, as shown.
- Verify the Center of Gravity is in the correct location 60 – 68mm back from the leading edge break, before flying.

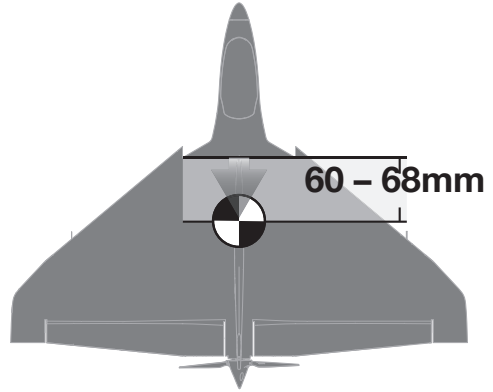

**IMPORTANT:** The GPS antenna should be installed flat in the fuselage facing upward, as shown below.  
**IMPORTANT:** Do not kink or cut the GPS antenna cable. Antenna wires are coaxial wires, kinks or cuts will degrade performance.\*

### GPS and Battery Placement

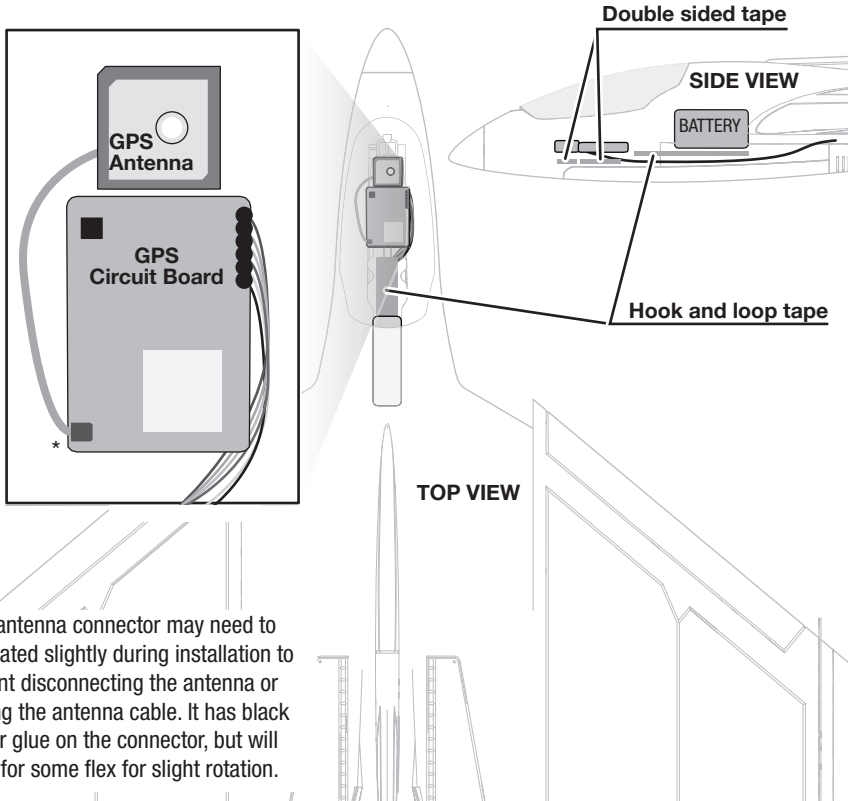

\*The antenna connector may need to be rotated slightly during installation to prevent disconnecting the antenna or kinking the antenna cable. It has black rubber glue on the connector, but will allow for some flex for slight rotation.

## Optional SAFE+ GPS Upgrade

### Compass Calibration

Compass calibration is required after installing the GPS module, before flight. The aircraft will automatically enter compass calibration on the first power up after the GPS module is installed, after binding.

**IMPORTANT:** The aircraft must be outside and needs to acquire a GPS lock in order to begin compass calibration. The aircraft will not enter compass calibration mode until the GPS lock is established.

Perform the compass calibration before the first flight or to correct the heading during auto landing if it varies significantly from the heading set during takeoff.

1. Remove the propeller if it is installed or activate throttle cut.
2. With the transmitter trims centered, and in high rates, power on the transmitter while holding the transmitter sticks as shown.
3. Power on the receiver and set the model on the ground. The aircraft will indicate the GPS is searching for satellites by cycling the elevator up and down.
4. After satellites are acquired, the aircraft will signal it has entered compass calibration mode: The elevons will cycle left and right slowly, and the red and green LEDs on the flight controller will flash alternately.  
Once in calibration mode, the throttle is not active and the transmitter sticks can be released. The transmitter must remain powered on.
5. In calibration mode, flip the aircraft twice nose over tail as shown in the step 5 diagram.
6. Turn the aircraft 90 degrees and roll the aircraft twice, as shown in the step 6 diagram.
7. Turn off the transmitter.
8. Wait 3 seconds and disconnect the flight battery.



**CAUTION:** Keep aircraft away from magnetic sources such as cameras, camera mounts, speakers ect. These may interfere with the GPS system and loss of control may result.

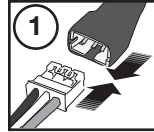

2

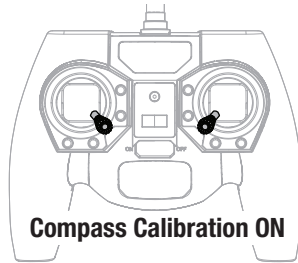

4

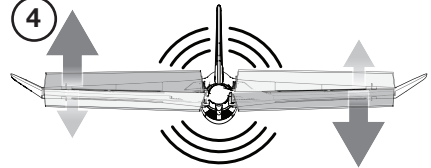

5

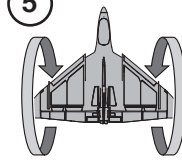

2 Full Rotations

6

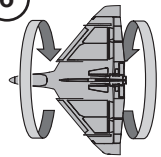

2 Full Rotations

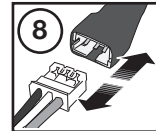

### Compass Error

If at any time you experience no throttle response after power up and the ailerons are deflected full right, the aircraft is indicating a compass error. Disconnect the flight battery and perform the compass calibration procedure.

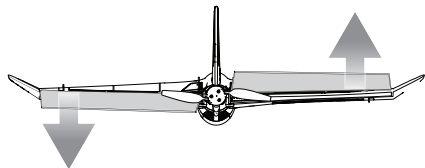

## Optional SAFE+ GPS Upgrade

### Flight Modes

Beginner, Intermediate and Experienced modes still operate the same with SAFE+ as they did with SAFE. With SAFE+, The Holding Pattern (HP) and AutoLand (AL) modes may be used as well.

#### Holding Pattern and AutoLand Trigger:

**Holding Pattern:** Press and release the HP/AL trigger. Press and release the HP/AL trigger again to exit.

**AutoLand:** Press and hold the HP/AL trigger for 4 seconds. Press and release the HP/AL trigger again to abort AutoLand.

Changing the flight mode will exit Holding Pattern or AutoLand and resume manual control in the selected flight mode.

The "1" button is used for these features on BNF models when using the recommended transmitter setup.

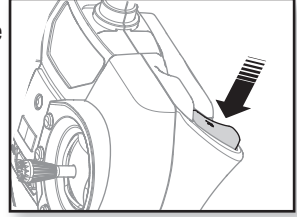

### Flying the Delta Ray One with SAFE+

- Sensor Assisted Flight Envelope (SAFE® Plus) technology is designed as flight assistance, not an autopilot. The pilot should fly the aircraft at all times.
- Start in Beginner mode (Flight Mode switch position 0). As you learn and become more confident, change modes to advance your flying skills.
- Fly your aircraft outside in no greater than winds up to 12 mph (16 km/h).
- Always launch your aircraft directly into the wind if possible.
- For indoor flight, turn off the GPS to fly the aircraft inside buildings like a large gymnasium.
- When flying in Autoland mode, the aircraft flight path may be adjusted with the transmitter controls, release the controls to let the GPS system resume command.
- The Delta Ray One with SAFE+ technology added does not have obstacle avoidance technology, be prepared to guide the aircraft if it is headed toward a tree or other object.

### In-Flight GPS OFF



The GPS can be turned off during flight at any time by pressing and holding the trigger while toggling the flight mode switch back and forth three complete cycles. This will disable all GPS features (Virtual Fence, Holding Pattern and AutoLand) and allow pilot to manually control the aircraft.

- If GPS is lost in flight or the GPS is installed backwards the aircraft wags the wing right then left then pitches up then down then the motor pulses like low battery.
- If GPS is turned off in flight manually you see the same wag and pitch with no motor pulse.

**IMPORTANT:** If you experience GPS signal loss, perform a compass calibration before your next flight.

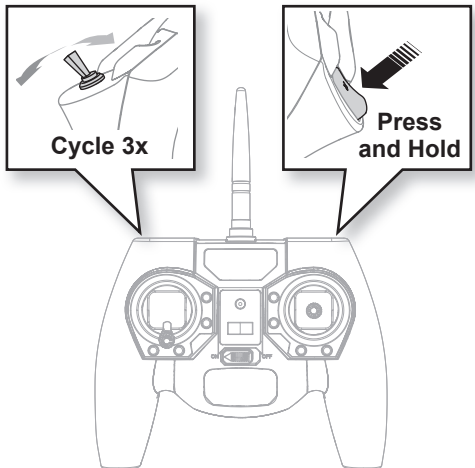

# Optional SAFE+ GPS Upgrade

## Virtual Fence Mode and GPS



**CAUTION:** Keep aircraft away from magnetic sources such as cameras, camera mounts, speakers ect. These may interfere with the GPS system and loss of control may result.

The SAFE+ upgrade system uses GPS to establish a home location and a virtual fence to keep the aircraft within a given distance from the home location. While flying, the aircraft will automatically turn around and fly back towards the home location if it approaches the edge of the virtual fence. Once back inside the fence, the aircraft will “wag” its wings, indicating full control has been given back to the pilot.

The Virtual Fence feature is active in all SAFE+ flight modes, provided the GPS function is active.

There are 4 variations of Virtual Fence mode, which are selectable from the transmitter while the aircraft GPS system initializes, and/or before a home location is set.

Apply and hold the appropriate following Transmitter stick positions when the aircraft is waiting for a GPS lock, or anytime after the GPS has acquired and before the home point is set in order to set the Virtual Fence Mode.

Once a Virtual Fence mode is chosen, the aircraft will remember that mode until another mode is chosen. It is not necessary to select the Virtual Fence mode every time the aircraft is powered on.

**IMPORTANT:** The transmitter must be set to high rate Aileron and Elevator (100%) in order to active the virtual fence selection.

**Virtual Fence Off:** turns off the Virtual Fence function. AutoLand and Holding Pattern are still available when virtual fence is off (with the optional GPS module installed).

Virtual Fence Mode	Transmitter Stick Position
<b>Virtual Fence OFF</b> <ul style="list-style-type: none"> <li>• Low throttle</li> <li>• Full right aileron</li> <li>• Full up elevator</li> <li>• LED Indication: Green LED flashes slowly</li> </ul>	
<b>Circle Virtual Fence, Small (Default)*</b> <ul style="list-style-type: none"> <li>• Low throttle</li> <li>• Full left aileron</li> <li>• Full up elevator</li> <li>• LED Indication: Green LED flashes slowly, Red LED flashes once</li> </ul>	
<b>Circle Virtual Fence, Large</b> <ul style="list-style-type: none"> <li>• Low throttle</li> <li>• Full left aileron</li> <li>• Full down elevator</li> <li>• LED Indication: Green LED flashes slowly, Red LED flashes twice</li> </ul>	
<b>Airfield Virtual Fence</b> <ul style="list-style-type: none"> <li>• Low throttle</li> <li>• Full right aileron</li> <li>• Full down elevator</li> <li>• LED Indication: Green LED flashes slowly, Red LED flashes Three times</li> </ul>	

LEDs are located under the magnetic hatch on the flight controller.

\*When flying the Delta Ray One Aircraft with the RTF MLP6 transmitter and the optional GPS module, only use the Small Circle Virtual Fence option.

## Optional SAFE+ GPS Upgrade

### Virtual Fence Mode and GPS

**Circle Virtual Fence, Small (Default):** sets the virtual fence in a circle with a radius of approximately 280 ft (85m) from the home location.

**Circle Virtual Fence, Large:** sets the virtual fence in a circle with a radius of approximately 500 ft (125m) from the home location.

#### Circle Virtual Fence

The small circle is intended to keep the plane closer in until you become comfortable with flying. Once familiar with flying the larger circle will let you go further out but the plane will look smaller and orientation could be more difficult at first.

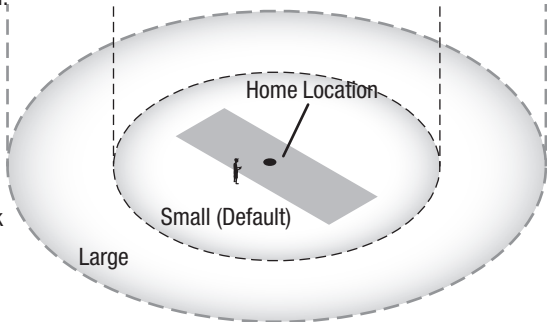

**Airfield Virtual Fence:** sets the virtual fence to an area approximately 656 ft (200m) long x 238 ft (100m) wide and establishes a “no fly zone” approximately 13 feet (4m) inside of the center line of the set aircraft heading to keep the aircraft from flying behind the pilot or over a pit area.

#### Airfield Virtual Fence

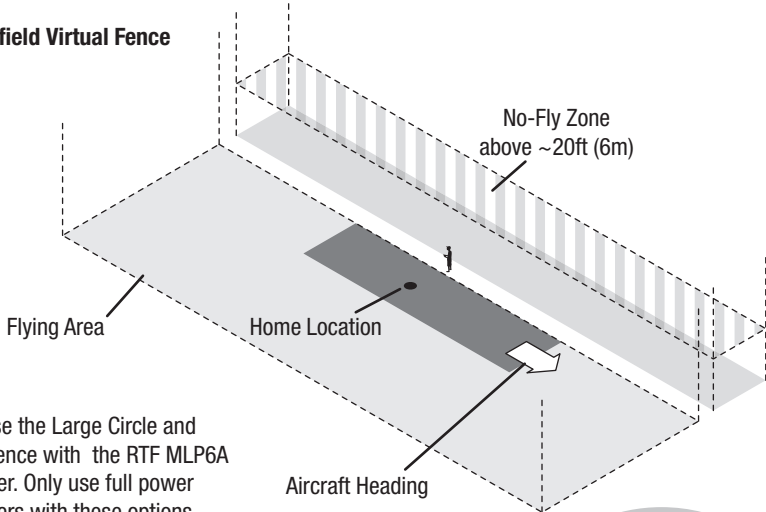

Do not use the Large Circle and Airfield Fence with the RTF MLP6A transmitter. Only use full power transmitters with these options.

**WARNING:** Never attempt to fly under the no fly zone. The bottom of the no fly zone is elevated to only allow for transport of the aircraft in the pit area of the airfield. Due to variances in the barometric sensor, attempting to fly in this area may cause the aircraft to suddenly fly back toward the home location, during which time the pilot will have no control over the aircraft until the aircraft reaches the home location. The pilot will have no way to avoid any obstacles between the no fly zone and the home location.

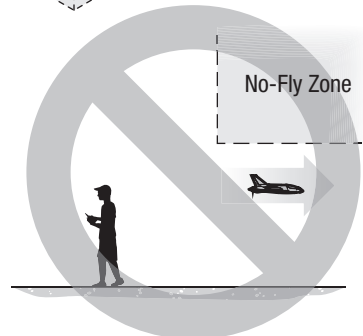



# Optional SAFE+ GPS Upgrade

## Holding Pattern (HP)

If at anytime the aircraft seems too far away, press and release the HP/AL (bind) button on the transmitter.

The aircraft will maneuver to an altitude of approximately 120 feet (36m) and begin to fly a circular pattern over the home location.

If Airfield Virtual Fence mode is active, the aircraft will fly to approximately 120 ft (36m) altitude and fly a circular pattern about 100 ft (30m) in front of the home location.

The aircraft flies fully autonomously when HP mode is active. The transmitter sticks have no control.

**NOTICE:** As a safety precaution, Holding Pattern mode will not function when your aircraft is below an altitude of approximately 10 ft (3m).

To deactivate HP mode and regain control, press and release the HP/AL button again or change flight modes.

**IMPORTANT:** When the HP feature is activated, the aircraft should immediately respond to the command. If the aircraft does not respond immediately, GPS signal may have been lost. In this case, the aircraft will have to be flown back to the home location manually.

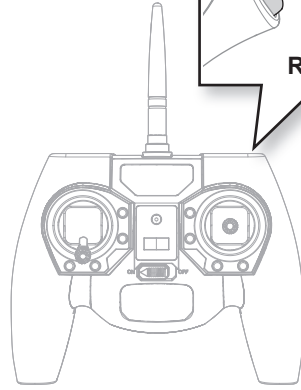

Holding Pattern Mode

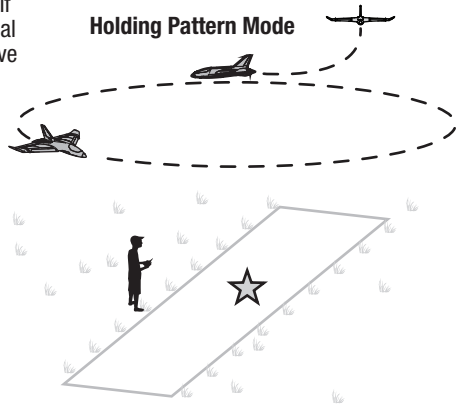

Holding Pattern Mode,  
Airfield Virtual Fence  
Active

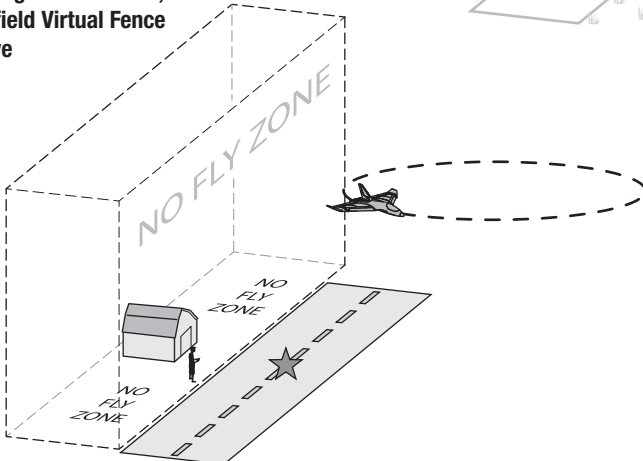

## Optional SAFE+ GPS Upgrade

### AutoLand (AL)

When you are ready to land or your flight timer has signaled, press and hold the red HP/AL button on the transmitter for 4 seconds.

The aircraft will instantly respond and begin a landing approach in the direction set during initialization. The aircraft will land near your initialization point/location and come to a complete stop.

When AutoLand is activated, you can still control the aircraft to avoid obstacles like trees or poles. The aircraft will allow you to make corrections if you apply aileron or elevator commands, and will momentarily return throttle control to the throttle stick while the elevator or aileron commands are being used. Once clear of the obstacles just let go of the control sticks and the AutoLand feature will take over and resume the landing.

At any time you can abort a landing by pressing and releasing the HP/AL button or by changing the flight mode.

If you want to takeoff again after landing pull the throttle to low position and then press the red HP/AL button again to deactivate AutoLand, or change flight modes.

**IMPORTANT:** The AutoLand feature can not be initiated when your aircraft is below an altitude of approximately 10ft (3m).

**NOTICE:** The AutoLand feature does not possess the ability to avoid obstacles. Ensure that your flying location is free of obstacles (trees, buildings, etc) before you start flying.

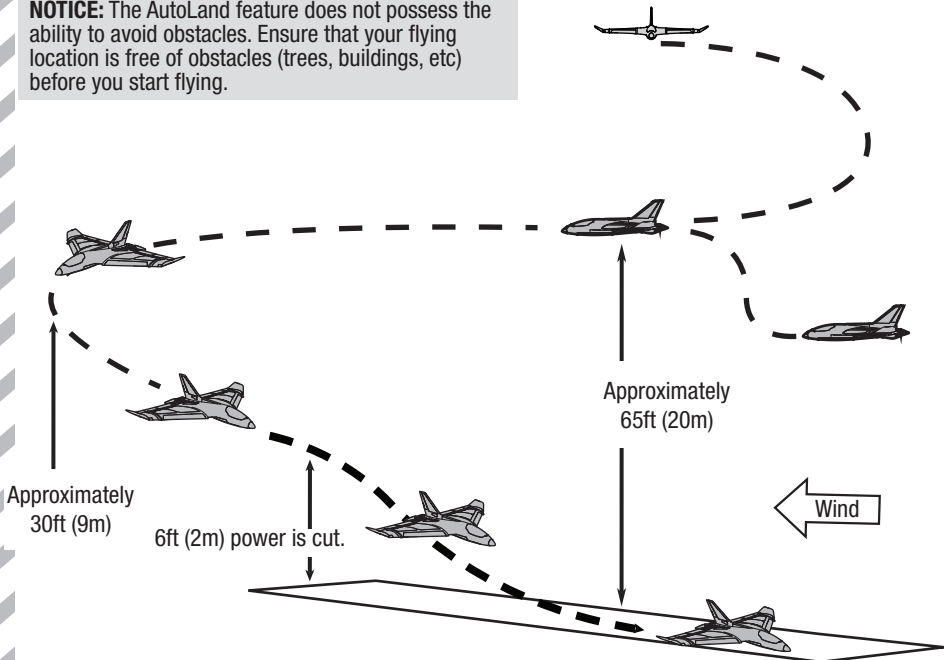
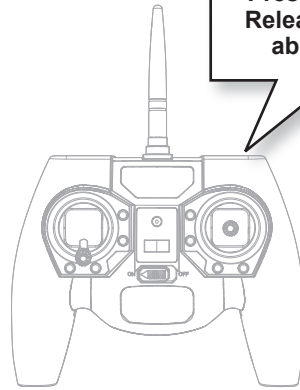

## Optional SAFE+ GPS Upgrade

### Powering On with GPS

#### GPS Initialization and Establishing Home Location



**CAUTION:** Keep aircraft away from magnetic sources such as cameras, camera mounts, speakers ect. These may interfere with the GPS system and loss of control may result.

1. Power on the transmitter.
2. Install a fully charged flight battery, following the instructions in the *Install the Flight Battery* section. If you have not completed the binding process, bind the aircraft and transmitter now.
3. Once the RF link has been established, the elevator will move up and down slowly, indicating the aircraft is searching for GPS lock.
  - If you wish to change the virtual fence mode, input the transmitter stick commands as described in the *Virtual Fence Mode and GPS* section while the aircraft is searching for GPS lock. The fence can be changed at any time before the home point is set.
  - The elevator movement will speed up as satellites are located.
  - The elevator will quickly move and then center to indicate GPS lock.

**IMPORTANT:** The control surfaces will respond once the GPS has acquired a lock, but the throttle is not active and will not arm until the home location is set.

4. Place the aircraft on the ground at the desired home location, and pointed into the wind to set the landing direction. Press and hold the HP/AL (bind) button until the elevons wag to set the home location.
  - If either of the circle Virtual Fence modes are active or if virtual fence is off, the elevons will wag and the throttle will now operate, indicating the aircraft is ready for flight.
  - If the Airfield Virtual Fence mode is active, the elevons will wag left and right. After setting the home location you must then indicate where the flying side of the airfield is in relation to the home location. The throttle will be inactive until the flying side direction is set. Set the flying side direction by moving the aileron stick either left or right in the direction of the flying area:
    - If the flying side is off the right wing of the aircraft as it sits in the home location, push the aileron stick right to the stop and release (as shown in the example below).
    - If the flying side is off the left wing as the aircraft sits in the home location, push the aileron stick left to the stop and release.

Once the home location and flying location is set, the control surfaces will wag and the motor will arm, indicating the aircraft is ready for flight.

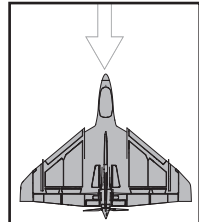

Place the model on the ground pointed into the wind to set the home location



**CAUTION:** If the aircraft is in Airfield mode, the line that defines the no fly zone will be aligned with the center line of the aircraft. Ensure the aircraft is point directly down the runway in one direction or the other to correctly set the Airfield mode. If the aircraft is not aligned with the runway, the no fly zone will not be set in the correct location.

#### Airfield Virtual Fence: Set the home location and aircraft heading

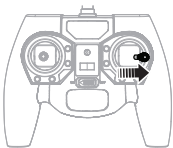
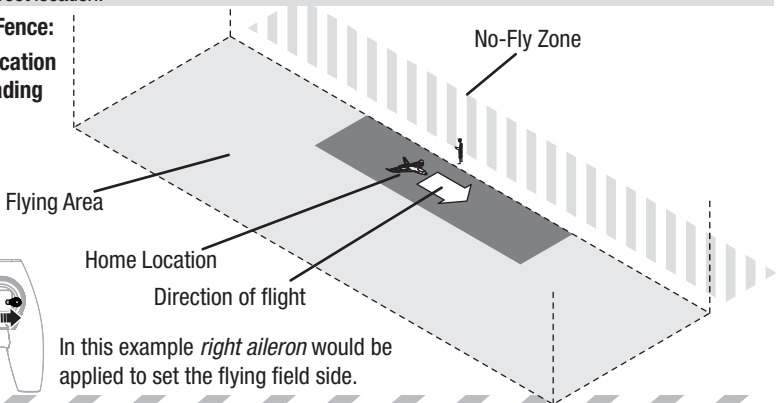

In this example *right aileron* would be applied to set the flying field side.

## Optional SAFE+ GPS Upgrade

### Disabling GPS

The GPS system will not be able to establish a GPS lock if activated while indoors. GPS will need to be turned off before operation indoors can take place. The aircraft will be unresponsive to transmitter commands while searching for a GPS signal.

#### Turning GPS off

1. Bind the aircraft and transmitter.
  2. Power on the transmitter with throttle and throttle trim fully lowered.
  3. Power on the aircraft, the motor makes three tones and then, the elevators will slowly move up and down, indicating the aircraft is searching for GPS lock.
  4. Press and hold the HP/AL (I) button and toggle the Flight Mode Switch back and forth through three full cycles to disable GPS.
- If the GPS module is connected, this process must be completed every time the aircraft is powered on in order to operate the model without a GPS signal.
  - If GPS is lost in flight or the GPS is installed backwards the aircraft wags the wing right then left then pitches up then down then the motor pulses like low battery.
  - If GPS is turned off in flight manually you see the same wag and pitch with no motor pulse.
  - GPS cannot be reactivated. The only way to restart GPS is to power cycle the plane. If you wanted to fly without GPS you would need to deactivate it before each flight or unplug it.



# Optional SAFE+ GPS Upgrade

## Troubleshooting Guide (SAFE® Plus)

Problem	Possible Cause	Solution
Aircraft will not respond to throttle but responds to other controls	AutoLand was not deactivated after landing	Deactivate AutoLand by pressing the AL/HP button or changing flight modes and lower throttle
	Home location has not been set	Set the home location
	Direction of Airfield fence has not been set.	Use aileron command to set the fence location.
Ailerons go up aircraft will not bind to transmitter (during binding)	Transmitter too near aircraft during binding process	Power off transmitter, move transmitter a larger distance from aircraft, disconnect and reconnect flight battery to aircraft and follow binding instructions
	Bind switch or button not held long enough during bind process	Power off transmitter and repeat bind process
	Aircraft or transmitter is too close to large metal object, wireless source or another transmitter	Move aircraft and transmitter to another location and attempt binding again
	Aircraft was not placed upright	Place aircraft upright after powering up
Ailerons go up and aircraft will not respond to transmitter (after binding)	Less than a 90-second wait between first powering on transmitter and connecting flight battery to aircraft	Leaving transmitter on, disconnect and reconnect flight battery to aircraft
	Aircraft was not upright, level or motionless	Leaving transmitter on, disconnect and reconnect flight battery to aircraft assuring that the aircraft is upright, level and motionless
	Aircraft cannot acquire a GPS signal	Turn off GPS
		Move to an outdoor location away from metal or concrete and try again
Aux1 (CH 6) reversed	Reverse Aux1	
Aircraft will not enter compass calibration	Aircraft cannot acquire a GPS signal	Move to an outdoor location away from metal or concrete and try again
Motor does not respond after landing	Over Current Protection (OCP) stops the motor when the transmitter throttle is set high and the propeller cannot turn	Fully lower throttle and throttle trim to arm ESC
	AutoLand has not been deactivated	Press and release HP/AL button to deactivate AutoLand feature
Motor pulses but battery is fully charged, not an LVC motor pulse	Lost GPS Signal	Turn off the GPS functions
		Try flying at a different location

**IMPORTANT:** If the optional GPS module is installed, turn the GPS function off before doing a range test.

The Delta Ray One aircraft is not compatible with DX4e or DX5e transmitters or the original version of the MLP6DSM transmitter when using GPS features

## Optional FPV Upgrade

### FPV Camera with OSD

**NOTICE:** Consult local laws and ordinances before operating FPV (first person view) equipment. In some areas, FPV operation may be limited or prohibited. You are responsible for operating this product in a legal and responsible manner.

The optional FPV camera features an integrated 25mw video transmitter and an On Screen Display system (OSD). The OSD delivers the pilot useful information on the video display. The OSD shows the Flight Mode, time aloft, and voltage. A call sign is also available on the OSD to display your HAM call sign to satisfy amateur radio rules.

Installing the optional FPV camera BLH8852 on the Delta Ray One requires the option part EFL9511 to connect the camera to the aircraft. Remove the magnetic hatch on the bottom of the aircraft and see the diagram for details of where to connect the FPV Camera Cable.

Mount the camera to the aircraft with double sided tape.

#### OSD Menu

The OSD has a menu system which has options where the pilot can make changes. The video transmitter frequency is set directly from the OSD menu.

- To enter the menu the model must be powered on, connected to the transmitter, and enable throttle cut. For the RTF transmitter fully lower the throttle trim.
- Flip the flight mode switch back and forth twice to enter the menu.
- To navigate the menu use the elevator stick to move up and down through the menu, and aileron stick to move side to side through the menu.

#### Available Frequencies, North America (mHz)

Band	CH 1	CH 2	CH 3	CH 4	CH 5	CH 6	CH 7	CH 8
Band A	5865	5845	5825	5805	5785	5765	5745	5725
Band B	5733	5752	5771	5790	5809	5828	5847	5866
Band E	5705	5685	5665	5665	5885	5905	5905	5905
FS/IRC	5740	5760	5780	5800	5820	5840	5860	5880
RaceBand	5658	5695	5732	5769	5806	5843	5880	5917

#### Available Frequencies, European Union (mHz)

Band	CH 1	CH 2	CH 3	CH 4	CH 5	CH 6	CH 7	CH 8
Band A	5865	5845	5825	5805	5785	5765	5745	5745
Band B	5733	5752	5771	5790	5809	5828	5847	5866
FS/IRC	5740	5760	5780	5800	5820	5840	5860	5860
RaceBand	5732	5732	5732	5769	5806	5843	5843	5843

#### Flight Mode

When powering up the aircraft to fly, the OSD will display the armed status in the upper left corner.

When the aircraft has a solid connection to the RC controller, the OSD will display DISARMED

Once the aircraft is armed, the OSD will display the flight mode in the upper left corner.

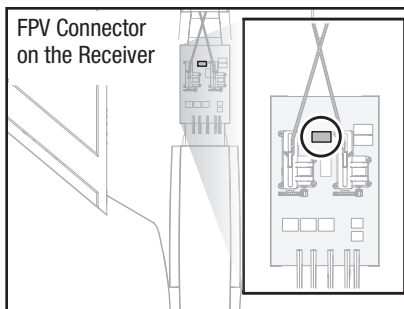

### On Screen Display

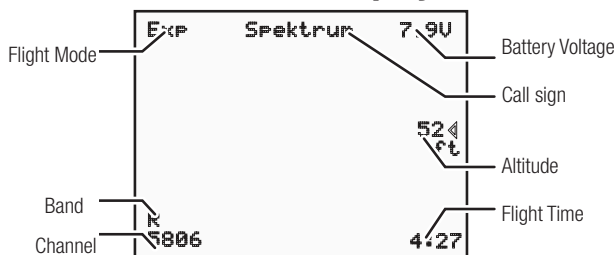

## Optional FPV Upgrade

### FPV features with the GPS module installed

When the FPV camera and the GPS module are connected, the OSD takes advantage of the GPS data available on the aircraft to deliver the pilot useful information on the video display. GPS adds Speed and altitude, GPS status, distance to home and an arrow pointing home.

The OSD can be helpful during preflight setup because it will display the status of the GPS, showing the pilot when the model has a sufficient GPS lock and is ready to fly.

### On Screen Display with GPS

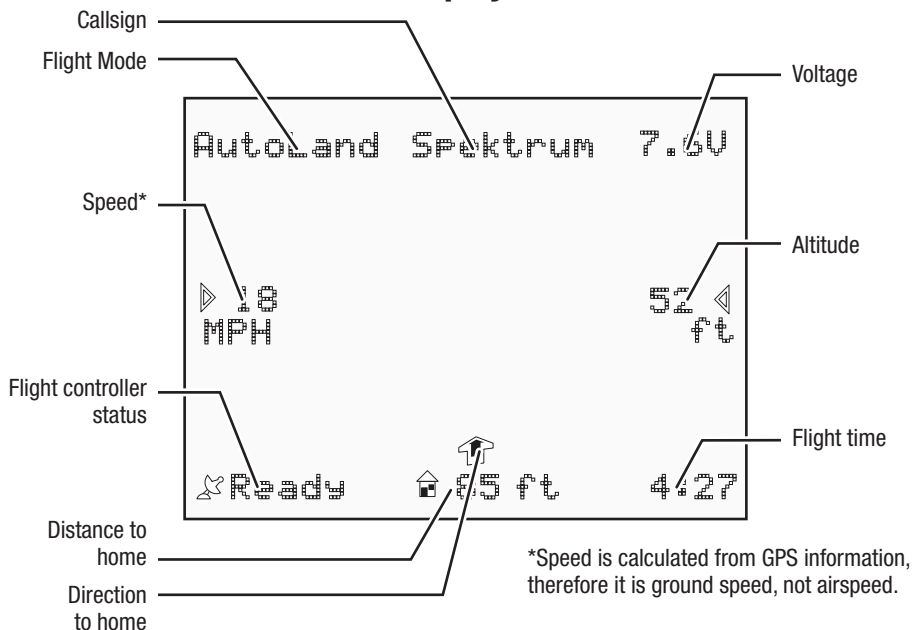

### Flight Controller Status

When powering on the airplane to fly with GPS, the OSD will display the flight status in the lower left corner.

- When first powered on, the OSD will show **INITIALIZING**
- When the aircraft is connected to the RC controller and has a GPS lock, the OSD will display **READY**
- When the GPS is connected, the aircraft will not respond to transmitter commands until the status changes to **READY**, unless the GPS is turned off.

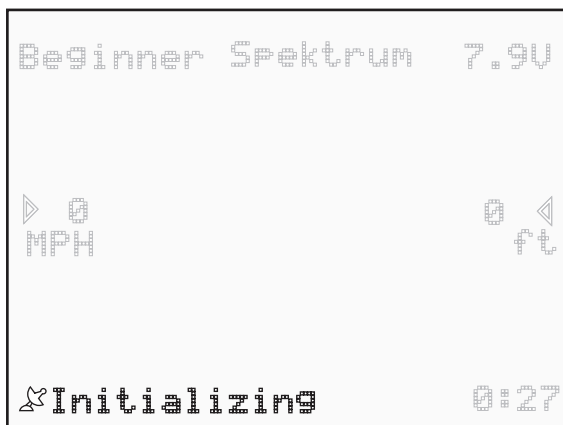

Plane Status	On-board LED Indication and required	Surface Movement
Receiver calibration	Flash red slowly	Elevons are centered.
Plane ready to bind	red and green LEDs flash rapidly	Elevons are centered.
Loss of control signal	Flash red rapidly	See troubleshooting guide for RF loss
AUX 1 on controller is reversed	Flash green rapidly	Elevons go to full up position
Compass/GPS initialization failed/ GPS not connected	Red and green LEDs turn solid for two seconds	Elevons alternate moving four times
Search for GPS lock	Red and green LEDs flash rapidly	Elevons move slowly up and down together
Virtual Fence indication (GPS is locked, Home location is not set)	Green LED flash slowly. Red LED flash 0-3 0 time-Virtual Fence Off 1 time-Circle Virtual Fence, small 2 times-Circle Virtual Fence, large 3 times-Airfield Virtual Fence	Elevons move rapidly four times together
Virtual Fence Modes can be changed after GPS is locked and before Home location is set	Refer to virtual fence mode section in this manual for stick positions	Setting is done: Elevons move in opposite directions four times
Compass calibration (If calibration has never been done, the aircraft will enter compass calibration mode after GPS is locked)	Red and green LED flash slowly alternatively Enter calibration (see Compass Calibration)	Elevons cycle up and down in opposite directions
Home location is set in virtual fence off or circle virtual fence modes	Press and hold the bind button for 3 seconds to set home location and wind direction.	Elevons cycle up and down in opposite directions four times.
Home location is set in airfield virtual fence mode (before airfield is set)	Press and hold the bind button for 3 seconds to set home location and runway orientation.	Both surfaces take turns to move to same direction four times.
Airfield area is set for airfield virtual fence mode:	Toggle aileron stick left/right to set airfield	Corresponding elevon moves rapidly four times.
Beginner Flight Mode	(switch position: 0) Green LED stays solid	
Intermediate Flight Mode	(switch position: 1) Green and red LEDs stay solid	
Experienced Flight Mode	(switch position: 2) Red LED stays solid	
Plane automatically turns around and flies back to the home location after it approaches the edge of the virtual fence.	Green LED flashes slowly	
Holding Pattern Mode	Enter: Press HP/AL trigger Abort: Press HP/AL trigger Green LED flashes slowly	
AutoLand Mode	Enter: Press and hold HP/AL trigger for three seconds Abort/Exit: Press HP/AL trigger Green LED flashes slowly	
GPS is turned off manually after initialization is done.	Disable GPS: Press and hold the bind button and toggle the flight mode switch 3 times Green and red LEDs flash slowly	Aircraft pitches up and down and then wags its wings
Low Voltage Cutoff		Motor pulse
GPS is installed backwards	Green and red LEDs flash slowly	Motor pulse 5 seconds after takeoff.
GPS is lost during flight	Green and red LEDs flash slowly	Aircraft pitches up and down and then wags its wings



## Limited Warranty

### What this Warranty Covers

Horizon Hobby, LLC, (Horizon) warrants to the original purchaser that the product purchased (the "Product") will be free from defects in materials and workmanship at the date of purchase.

### What is Not Covered

This warranty is not transferable and does not cover (i) cosmetic damage, (ii) damage due to acts of God, accident, misuse, abuse, negligence, commercial use, or due to improper use, installation, operation or maintenance, (iii) modification of or to any part of the Product, (iv) attempted service by anyone other than a Horizon Hobby authorized service center, (v) Product not purchased from an authorized Horizon dealer, or (vi) Product not compliant with applicable technical regulations, or (vii) use that violates any applicable laws, rules, or regulations.

OTHER THAN THE EXPRESS WARRANTY ABOVE, HORIZON MAKES NO OTHER WARRANTY OR REPRESENTATION, AND HEREBY DISCLAIMS ANY AND ALL IMPLIED WARRANTIES, INCLUDING, WITHOUT LIMITATION, THE IMPLIED WARRANTIES OF NON-INFRINGEMENT, MERCHANTABILITY AND FITNESS FOR A PARTICULAR PURPOSE. THE PURCHASER ACKNOWLEDGES THAT THEY ALONE HAVE DETERMINED THAT THE PRODUCT WILL SUITABLY MEET THE REQUIREMENTS OF THE PURCHASER'S INTENDED USE.

### Purchaser's Remedy

Horizon's sole obligation and purchaser's sole and exclusive remedy shall be that Horizon will, at its option, either (i) service, or (ii) replace, any Product determined by Horizon to be defective.

Horizon reserves the right to inspect any and all Product(s) involved in a warranty claim. Service or replacement decisions are at the sole discretion of Horizon. Proof of purchase is required for all warranty claims. SERVICE OR REPLACEMENT AS PROVIDED UNDER THIS WARRANTY IS THE PURCHASER'S SOLE AND EXCLUSIVE REMEDY.

### Limitation of Liability

HORIZON SHALL NOT BE LIABLE FOR SPECIAL, INDIRECT, INCIDENTAL OR CONSEQUENTIAL DAMAGES, LOSS OF PROFITS OR PRODUCTION OR COMMERCIAL LOSS IN ANY WAY, REGARDLESS OF WHETHER SUCH CLAIM IS BASED IN CONTRACT, WARRANTY, TORT, NEGLIGENCE, STRICT LIABILITY OR ANY OTHER THEORY OF LIABILITY, EVEN IF HORIZON HAS BEEN ADVISED OF THE POSSIBILITY OF SUCH DAMAGES. Further, in no event shall the liability of Horizon exceed the individual price of the Product on which liability is asserted. As

Horizon has no control over use, setup, final assembly, modification or misuse, no liability shall be assumed nor accepted for any resulting damage or injury. By the act of use, setup or assembly, the user accepts all resulting liability. If you as the purchaser or user are not prepared to accept the liability associated with the use of the Product, purchaser is advised to return the Product immediately in new and unused condition to the place of purchase.

### Law

These terms are governed by Illinois law (without regard to conflict of law principals). This warranty gives you specific legal rights, and you may also have other rights which vary from state to state. Horizon reserves the right to change or modify this warranty at any time without notice.

### WARRANTY SERVICES

#### Questions, Assistance, and Services

Your local hobby store and/or place of purchase cannot provide warranty support or service. Once assembly, setup or use of the Product has been started, you must contact your local distributor or Horizon directly. This will enable Horizon to better answer your questions and service you in the event that you may need any assistance. For questions or assistance, please visit our website at [www.horizonhobby.com](http://www.horizonhobby.com), submit a Product Support Inquiry, or call the toll free telephone number referenced in the Warranty and Service Contact Information section to speak with a Product Support representative.

#### Inspection or Services

If this Product needs to be inspected or serviced and is compliant in the country you live and use the Product in, please use the Horizon Online Service Request submission process found on our website or call Horizon to obtain a Return Merchandise Authorization (RMA) number. Pack the Product securely using a shipping carton. Please note that original boxes may be included, but are not designed to withstand the rigors of shipping without additional protection. Ship via a carrier that provides tracking and insurance for lost or damaged parcels, as Horizon is not responsible for merchandise until it arrives and is accepted at our facility. An Online Service Request is available at [http://www.horizonhobby.com/content/service-center\\_renderer-service-center](http://www.horizonhobby.com/content/service-center_renderer-service-center). If you do not have internet access, please contact Horizon Product Support to obtain a RMA number along with instructions for submitting your product for service. When calling Horizon, you will be asked to provide your complete name, street address, email address and phone number where you can be reached during business hours. When sending product into

Horizon, please include your RMA number, a list of the included items, and a brief summary of the problem. A copy of your original sales receipt must be included for warranty consideration. Be sure your name, address, and RMA number are clearly written on the outside of the shipping carton.

**NOTICE: Do not ship LiPo batteries to Horizon. If you have any issue with a LiPo battery, please contact the appropriate Horizon Product Support office.**

#### Warranty Requirements

**For Warranty consideration, you must include your original sales receipt verifying the proof-of-purchase date.** Provided warranty conditions have been met, your Product will be serviced or replaced free of charge. Service or replacement decisions are at the sole discretion of Horizon.

#### Non-Warranty Service

**Should your service not be covered by warranty, service will be completed and payment will be required without notification or estimate of the**

**expense unless the expense exceeds 50% of the retail purchase cost.** By submitting the item for service you are agreeing to payment of the service without notification. Service estimates are available upon request. You must include this request with your item submitted for service. Non-warranty service estimates will be billed a minimum of ½ hour of labor. In addition you will be billed for return freight. Horizon accepts money orders and cashier's checks, as well as Visa, MasterCard, American Express, and Discover cards. By submitting any item to Horizon for service, you are agreeing to Horizon's Terms and Conditions found on our website [http://www.horizonhobby.com/content/service-center\\_render-service-center](http://www.horizonhobby.com/content/service-center_render-service-center).

**ATTENTION: Horizon service is limited to Product compliant in the country of use and ownership. If received, a non-compliant Product will not be serviced. Further, the sender will be responsible for arranging return shipment of the un-serviced Product, through a carrier of the sender's choice and at the sender's expense. Horizon will hold non-compliant Product for a period of 60 days from notification, after which it will be discarded.**

10/15

## Contact Information

Country of Purchase	Horizon Hobby	Contact Information	Address
United States of America	Horizon Service Center (Repairs and Repair Requests)	servicecenter.horizonhobby.com/ RequestForm/	2904 Research Rd. Champaign, Illinois, 61822 USA
	Horizon Product Support (Product Technical Assistance)	productsupport@horizonhobby.com 877-504-0233	
	Sales	websales@horizonhobby.com 800-338-4639	
European Union	Horizon Technischer Service	service@horizonhobby.eu	Hanskampring 9 D 22885 Barsbüttel, Germany
	Sales: Horizon Hobby GmbH	+49 (0) 4121 2655 100	

## FCC Information

FCC ID: BRWDXMTX10,

BRWHBZCHAMP2S

This device complies with part 15 of the FCC rules. Operation is subject to the following two conditions: (1) This device may not cause harmful interference, and (2) this device must accept any interference received, including interference that may cause undesired operation.

**CAUTION:** Changes or modifications not expressly approved by the party responsible for compliance could void the user's authority to operate the equipment.

This product contains a radio transmitter with wireless technology which has been tested and found to be compliant with the applicable regulations governing a radio transmitter in the 2.400GHz to 2.4835GHz frequency range.

## Supplier's Declaration of Conformity

Delta Ray One BNF Basic w/SAFE

EFL9550

 This device complies with part 15 of the FCC Rules. Operation is subject to the following two conditions: (1) This device may not cause harmful interference, and (2) this device must accept any interference received, including interference that may cause undesired operation.

**CAUTION:** changes or modifications not expressly approved by the party responsible for compliance could void the user's authority to operate the equipment.

**NOTE:** This equipment has been tested and found to comply with the limits for a Class B digital device, pursuant to part 15 of the FCC Rules. These limits are designed to provide reasonable protection against harmful interference in a residential installation. This equipment generates, uses and can radiate radio frequency energy and, if not installed and used in accordance with the instructions, may cause harmful interference to radio communications. However, there is no guarantee that interference will not occur in a particular installation. If this equipment does cause harmful interference to radio or television reception, which can be determined by turning the equipment off and on, the user is encouraged to try to correct the interference by one or more of the following measures:

- Reorient or relocate the receiving antenna.
- Increase the separation between the equipment and receiver.
- Connect the equipment into an outlet on a circuit different from that to which the receiver is connected.
- Consult the dealer or an experienced radio/TV technician for help.

Horizon Hobby, LLC

4105 Fieldstone Rd.,

Champaign, IL 61822

Email: [compliance@horizonhobby.com](mailto:compliance@horizonhobby.com)

Web: [HorizonHobby.com](http://HorizonHobby.com)

## IC Information

CAN ICES-3 (B)/NMB-3(B)

IC: 6175A-BRWDXMT  
6157A-HBZCHAMP2S

This device complies with Industry Canada licence-exempt RSS standard(s).

Operation is subject to the following two conditions:

(1) this device may not cause interference,

(2) this device must accept any interference, including interference that may cause undesired operation of the device.

## Compliance Information for the European Union



### EU Compliance Statement:

EFL9550 DELTA RAY ONE BNF BASIC; Horizon Hobby, LLC hereby declares that this product is in compliance with the essential requirements and other relevant provisions of the RED Directive.

EFL9500 DELTA RAY ONE RTF; Horizon Hobby, LLC hereby declares that this product is in compliance with the essential requirements and other relevant provisions of the RED, EMC and LVD Directives.

A copy of the EU Declaration of Conformity is available online at:  
<http://www.horizonhobby.com/content/support-render-compliance>.



### Instructions for disposal of WEEE by users in the European Union

This product must not be disposed of with other waste. Instead, it is the user's responsibility to dispose of their waste equipment by handing it over to a designated collection point for the recycling of waste electrical and electronic equipment. The separate collection and recycling of your waste equipment at the time of disposal will help to conserve natural resources and make sure that it is recycled in a manner that protects human health and the environment. For more information about where you can drop off your waste equipment for recycling, please contact your local city office, your household waste disposal service or where you purchased the product.



**E328**

## Replacement Parts – Ersatzteile – – Pièces de rechange – Pezzi di ricambio –

Part # • Nummer Numéro • Codice	Description	Beschreibung	Description	Descrizione
EFL9501	Replacement Airframe: Delta Ray One	Ersatzfahrwerk: Delta Ray One	Fuselage de rechange : Delta Ray One	Cellula di ricambio: Delta Ray One
EFL9502	Vertical Fin: Delta Ray One	Stabilisierungsflosse: Delta Ray One	Dérive verticale : Delta Ray One	Aletta verticale: Delta Ray One
EFL9503	Hatches Front and Rear: Delta Ray One	Abdeckungen, vorne und hinten: Delta Ray One	Trappes avant et arrière : Delta Ray One	Sportelli anteriore e posteriore: Delta Ray One
EFL9504	Rubber Nose: Delta Ray One	Gumminase: Delta Ray One	Nez en caoutchouc : Delta Ray One	Muso in gomma: Delta Ray One
EFL9505	Pushrod Set: Delta Ray One	Gestängesatz: Delta Ray One	Ensemble de barres de liaisons : Delta Ray One	Set aste di comando: Delta Ray One
EFL9506	Plastic Parts Set: Delta Ray One	Kunststoffteile-Satz: Delta Ray One	Ensemble de pièces en plastique : Delta Ray One	Kit parti in plastica: Delta Ray One
EFL9507	Decal Sheet: Delta Ray One	Decalsatz: Delta Ray One	Feuille d'autocollants : Delta Ray One	Set decalcomanie: Delta Ray One
EFL9508	Spinner 23.5mm Pusher: Delta Ray One	Spinner 23,5 mm Pu- sher: Delta Ray One	Propulsion de 23,5 mm à cône : Delta Ray One	Ogiva 23,5 mm Spin- gente: Delta Ray One
EFL9509	RX/ESC Unit: Delta Ray One	RX/ESC-Einheit: Delta Ray One	Unité RX/Variateur ESC : Delta Ray One	Unità RX/ESC: Delta Ray One
EFLUM180BLR	BL180 Brushless Outrunner Motor, 3000Kv Reversed	BL180 bürstenloser Außenmotor, 3000 kV umgekehrt	Moteur à cage tournante sans balais BL180, 3 000 Kv inversé	Motore outrunner senza spazzole BL180, 3000 Kv invertito
EFLP13070FP	130 x 70mm Folding Prop Pusher: Delta Ray One	130 x 70 mm klappbarer Pusher-Propeller: Delta Ray One	Propulsion à hélice repliable de 130 x 70 mm : Delta Ray One	Spingente elica pieghevole 130 x 70 mm: Delta Ray One
EFLB2802S30	280 mAh 2S 7.4V 30C Li-Po Battery	280mAh 2S 7.4V 30C Li-Po	Batterie Li-Po 7.4V 2S 280mA 30C	Batteria Li-Po 280mAh 2S 7.4V 30C
EFLC4000	AC to 12V DC, 1.5Amp Power Supply	E-flite 1,5A Netzteil AC zu 12V DC	Alimentation secteur AC vers 12V DC 1,5A	AC > 12VDC, 1.5-Amp Alimentatore
EFLRMLP6A	MLP6ADSM Transmitter	MLP6ADSM Sender	Émetteur MLP6ADSM	Trasmittitore MLP6ADSM
EFLUC1007	Celectra 2S 7.4V DC Li-Po Charger	Celectra 2S 7.4V DC Li-Po Ladegerät	Celectra Chargeur Li-Po 7.4V 2S	Celectra 2S 7.4V DC Li-Po Caricabatterie

## Optional Parts – Optionale Bauteile – – Pièces optionnelles – Pezzi opzionali –

Part # • Nummer Numéro • Codice	Description	Beschreibung	Description	Descrizione
EFLUC1008	DC Power Cord:	E-filite DC-Anschlußkabel	Cordon d'alimentation DC	Cavo alimentazione DC
EFLA700UM	Charge Plug Adapter:	E-filite EFL Ladekabeladapter	Adaptateur de charge	Adattatore spina di carica
EFL9512	GPS Unit and Antenna (small)	Hobbyzone GPS-Unit: Champ S+	Champ S+ - Module GPS	Unità GPS: Champ S+
BLH8852	FPV Camera w/ OSD	FPV-Kamera mit OSD	Caméra FPV avec OSD	Videocamera FPV con OSD
EFL9511	FPV Extension Lead: Delta Ray One	FPV-Kameraleitung	Câble de caméra FPV	Videocamera FPV cavo
PKZ1039	Hook and Loop Set (5): Ultra Micros	Klettband (5): Ultra Micros	Bande autoagrippante (5)	Set fascette fi ssaggio (5): Ultra Micros
EFL9510	GPS Extension Lead: Delta Ray One	GPS-Verlängerungskabel: Delta Ray One	Prolongateur GPS: Delta Ray One	Piombo estensione GPS: Delta Ray One
	DXe DSMX 6-Channel Transmitter	Spektrum DXe DSMX 6-Kanal Sender	Emetteur DXe DSMX 6 voies	DXe DSMX Trasmettitore 6 canali
	DX6e DSMX 6-Channel Transmitter	Spektrum DX6e DSMX 6-Kanal Sender	Emetteur DX6e DSMX 6 voies	DX6e DSMX Trasmettitore 6 canali
	DX6 DSMX 6-Channel Transmitter	Spektrum DX6 DSMX 6-Kanal Sender	Emetteur DX6 DSMX 6 voies	DX6 DSMX Trasmettitore 6 canali
	DX7G2 DSMX 7-Channel Transmitter	Spektrum DX7 DSMX 7 Kanal Sender	Emetteur DX7 DSMX 7 voies	DX7 DSMX Trasmettitore 7 canali
	DX8G2 DSMX 8-Channel Transmitter	Spektrum DX8G2 DSMX 8 Kanal Sender	Emetteur DX8G2 DSMX 8 voies	DX8G2 DSMX Trasmettitore 8 canali
	DX9 DSMX 9-Channel Transmitter	Spektrum DX9 DSMX 9 Kanal Sender	Emetteur DX9 DSMX 9 voies	DX9 DSMX Trasmettitore 9 canali
	DX18 DSMX 18-Channel Transmitter	Spektrum DX18 DSMX 18 Kanal Sender	Emetteur DX18 DSMX 18 voies	DX18 DSMX Trasmettitore 18 canali
	DX20 DSMX 20-Channel Transmitter	Spektrum DX20 DSMX 20 Kanal Sender	Emetteur DX20 DSMX 20 voies	DX20 DSMX Trasmettitore 20 canali
	iX12 DSMX 12-Channel Transmitter	Spektrum iX12 DSMX 12 Kanal Sender	Emetteur iX12 DSMX 12 voies	iX12 DSMX Trasmettitore 12 canali



© 2019 Horizon Hobby, LLC.

E-flite, Delta Ray, SAFE, the SAFE logo, Celectra, Bind-N-Fly, BNF, the BNF logo, DSM, DSM2, DSMX, ModelMatch, and the Horizon Hobby logo are trademarks or registered trademarks of Horizon Hobby, LLC.

The Spektrum trademark is used with permission of Bachmann Industries, Inc.

US 9,056,667. US 8,672,726. Other Patents Pending.

<https://www.horizonhobby.com/content/e-flite-rc>